

SF25AION38X-Boost-EQ-RC-PCS-DS-15LH-110-27.5-AL1.5CTS-C74-O44-170,160

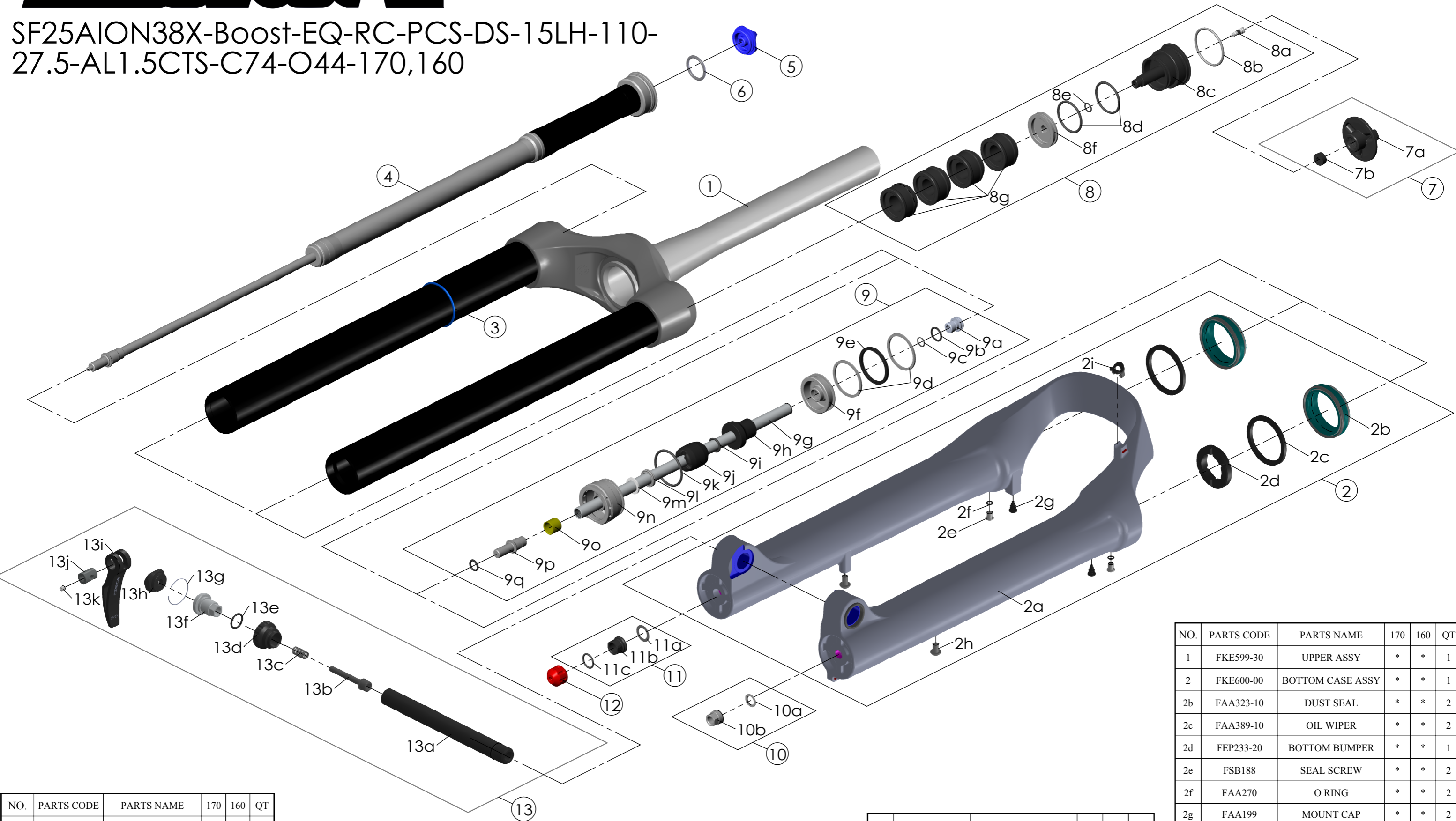

NO.	PARTS CODE	PARTS NAME	170	160	QT
9g	FPE002-68	SUPPORT TUBE	*		1
	FPE002-67			*	1
10	FKA063-03	FIXING NUT SET	*	*	1
11	FKE436-10	FIXING NUT SET	*	*	1
12	FEG201	REBOUND KNOB	*	*	1
13	FKA116-02	15LH-110 AXLE SET	*	*	1

NO.	PARTS CODE	PARTS NAME	170	160	QT
9	FKE577-06	SUPPORT TUBE ASSY	*		1
	FKE577-16			*	1

NO.	PARTS CODE	PARTS NAME	170	160	QT
7	FKE076-10	VALVE CAP ASSY	*	*	1
8	FKE525-14	VOLUME ADJUSTER ASSY	*		1
	FKE525-24			*	1
8g	FEG270-30	VOLUME REDUCER	*		3
				*	4

NO.	PARTS CODE	PARTS NAME	170	160	QT
1	FKE599-30	UPPER ASSY	*	*	1
2	FKE600-00	BOTTOM CASE ASSY	*	*	1
2b	FAA323-10	DUST SEAL	*	*	2
2c	FAA389-10	OIL WIPER	*	*	2
2d	FEP233-20	BOTTOM BUMPER	*	*	1
2e	FSB188	SEAL SCREW	*	*	2
2f	FAA270	O RING	*	*	2
2g	FAA199	MOUNT CAP	*	*	2
2h	FSB203	FIXING BOLT	*	*	2
2i	FEG034	CABLE CLIP	*	*	1
3	FAA397-20	O RING	*	*	1
4	FUN160-98	RC-PCS UNIT	*	*	1
5	FEE862	ADJUST KNOB	*	*	1
6	FAA136	O RING	*	*	1