

# 2K25

SUPERIOR MAGNESIUM  
ALLOY AND CARBON  
TECHNOLOGY

SUSPENSION FORKS  
REAR SHOCKS  
E-BIKE SYSTEMS

**SR SUNTOUR** 

VERSION 4.0 / 09-2024



**GOING BEYOND**

# CONTENT

## 2K25 HIGHLIGHTS / TECHNOLOGY & FEATURES

<b>INTRO</b> _____	03	<b>GLOSSARY SUSPENSION FORKS</b>		<b>GLOSSARY REAR SHOCKS</b>	
		FORK OVERVIEW _____	34	REAR SHOCK OVERVIEW _____	56
<b>TECHNOLOGY &amp; FEATURES</b>		EQ EQUALIZER SYSTEM _____	35	AIR SPRING MOUNT _____	57
RC+ TECHNOLOGY _____	04	PCS SYSTEM _____	37	SPECIFICATIONS _____	58
ABS MOUNT _____	05	PCS CARTRIDGES _____	39	DAMPING ADJUSTMENT _____	60
QSP PRODUCTS _____	06	DAMPING ADJUSTMENT _____	43	SHOCK & STROKE LENGTH _____	61
		SPRING SYSTEM _____	45	HOW TO MEASURE SAG _____	62
<b>SUSPENSION FORKS</b>		ADJUSTABLE AIR		ADJUSTABLE AIR	
RUX38 _____	07	CHAMBER VOLUME _____	46	CHAMBER VOLUME _____	63
DUROLUX38 / X _____	09	STANCHIONS _____	47	BUSHING PARTS / HOW TO	
AURON36 _____	11	BOTTOM CASE COLORS _____	48	MEASURE HARDWARE SIZE _____	64
AION38X _____	15	DECALS _____	48	AIR VOLUME OPTIONS _____	65
ZERON36 / X _____	17	QLOC & THRU AXLES _____	49		
MOBIE36 _____	19	HOLLOW CROWN _____	51	<b>FURTHER CONTENTS</b>	
AXON34 WERX _____	21	STEERER TUBE _____	51	SPECIAL DEALER NETWORK _____	128
RAIDON34X & JR _____	27	STANCHION DIAMETER _____	51	SPECIAL SERVICE TOOLS _____	129
GVX32 S _____	29	WHEEL SIZE _____	51	WEBSITE GUIDE _____	130
		BRAKE TYPE _____	52	SOCIAL MEDIA GUIDE _____	131
<b>REAR SHOCKS</b>		ABS MOUNT _____	52	WORLDWIDE DISTRIBUTORS	
TRIAIR2 _____	13	HEAD LAMP MOUNT _____	53	& SUBSIDIARIES _____	132
EDGE X _____	23	CABLE GUIDE _____	53		
EDGE EVO _____	25	SHORT FENDER _____	54		
		LONG FENDER MOUNTS _____	54		
<b>E-BIKE SYSTEM</b> _____	31				

## SPECIFICATIONS

<b>SUSPENSION FORKS</b>		M 3010 _____	98	<b>REAR SHOCKS</b>	
RUX _____	67	MOBIE 36 _____	99	TRIAIR _____	120
DUROLUX _____	68	MOBIE 34 _____	101	TRIAIR 2 _____	121
AURON _____	70	MOBIE 25 _____	104	EDGE X _____	122
AION _____	71	MOBIE A32 _____	105	EDGE EVO _____	123
ZERON _____	76	MOBIE A32 CGO _____	105	EDGE PLUS _____	124
AXON _____	79	MOBIE 34 CGO _____	106	EDGE _____	125
RAIDON _____	81	GVX _____	107	RAIDON _____	126
XCR _____	83	NRX _____	108		
EPIXON _____	87	NCX _____	110	<b>SUSPENSION SEAT POST</b>	
X1 _____	88	NX1 / TR-HSI _____	113	NCX _____	118
XCM _____	90	NVX _____	114	OTIS _____	119
XCT _____	95	NEX _____	115		
XCE _____	97	CR85-E25 _____	117	<b>REMOTE LEVER</b> _____	127



# *REFINED SIMPLICITY*

GOING BEYOND: SR SUNTOUR is the only suspension company that makes forks for every application, from kids to cargo bikes, from XC to DH mountain bikes, from urban to gravel bikes to eBikes and everything in between. SR SUNTOUR continues to innovate with a new range of e-bike ready forks, emphasizing safety, versatility and comfort for a wide variety of modern riding styles and applications. We also continue to push the boundaries of what's possible with our Olympic & World Cup winning TACT electrical suspension developed in conjunction with our WERX professional riders. But our main mission is getting people out on bicycles. Our products earn podiums at Red Bull Rampage and all of the disciplines at Crankworx is part of our commitment to quality and refinement. Creating the highest possible performance and value for all levels of cycling is our core philosophy. Our products will take your money farther with the quality and performance to allow you to ride farther...GOING BEYOND



# RC+ RIDE BOLD

**EXTRA OIL FLOW FOR HIGH SPEEDS  
AND HARD IMPACTS.**

Our new RC+ cartridge has extra oil flow for high speeds and hard impacts while still offering excellent performance for both small bumps and trail chatter. With a new semiopen oil bath & easy adjustment it means the best stability and suspension for you on the trail. RC+ is developed by our SR SUNTOUR engineers and top professional riders as part of our WERX program and available on our new DUROLUX38/X, DUROLUX36X and AURON36 forks. Learn more at [srsuntour.com/rc+](http://srsuntour.com/rc+)





**ABS-READY FORKS BY SR SUNTOUR**

## ***MORE TRACTION. MORE CONTROL.***



SR SUNTOUR has collaborated with leading industry partners to bring Anti-lock Braking Systems (ABS) to our forks across a range of cycling disciplines. The result is the superb damping, stability, and precise steering of our forks with the control and confidence inspired by direct-mount ABS for modern urban, sport,

### **ADVANTAGES OF ANTI-LOCK BRAKING SYSTEMS**

- More traction & control
- Enhanced stability & comfort
- Increased safety

### **SR SUNTOUR ABS FEATURES**

- Integrated design for a safe & strong ABS Unit mounting solution
- Increased fork stiffness supports ABS braking
- Robust direct mount for applications from urban to E-MTB
- Easy assembling following our Refined Simplicity approach
- Wheel speed sensor integration reduces risk of impact and contamination
- Safe and clean cable routing

# QSP

## QUICK SERVICE PRODUCTS

Refined simplicity is our guiding principle. »High performance made simple« is the foundation of every one of our developments. Our PCS cartridge system is fully synchronized with our approach to applying simplicity to our designs. It not only aims to be technologically sophisticated but also to be user-friendly and low-maintenance. Setup and maintenance are quick and easy and at a lower cost. All parts can be disassembled and the system can be bled and reassembled again without the use of special tools. We call them QSP - Quick Service Products. Offering quick service and state-of-the-art technology to our customers across all levels of riding is the philosophy behind QSP.

### QSP IS APPLIED THROUGHOUT OUR PRODUCT LINE

Here are some examples:

- Easy travel changes in both suspension forks and rear shocks
- Integrated fenders
- Sealed, fully serviceable and tunable cartridges
- Minimal number of tools needed to service SR SUNTOUR products
- Faster and easier service than our competitors
- Lubrication/air burp valves on the AURON, RUX and DUROLUX for consistent runs
- Easy to install air volume spacers to customize your ride for your terrain





# RUX

## RUX38 CONTINUED EVOLUTION OF BIG MOUNTAIN

The continued evolution of the RUX has gotten us to the RUX 29, the biggest and baddest SR SUNTOUR RUX yet. The RUX's list of accomplishments continues to grow with numerous appearances on the World Cup Downhill, Crankworx and Red Bull Rampage podiums. Our newest version accepts 29" wheels and features our Air EQ system which perfectly equalizes the rider's inputs to the spring curve creating the ultimate in support for whatever the mountain can throw at you. The PCS backed fully-sealed R2C2 and RC2 dampers will track every movement with precision while allowing you to fine tune the fork to your intended riding style. Once your ride is over, our QSP philosophy means you can quickly maintain and service your fork so you're ready for your next shred.

<b>MODEL</b>	RUX38 BOOST
<b>INTENDED USE</b>	DOWNHILL, FREERIDE
<b>TRAVEL</b>	200 mm
<b>WHEEL SIZES</b>	27.5", 29"
<b>SPRING</b>	AIR (27.5"), AIR EQ (29")
<b>CARTRIDGE</b>	R2C2-PCS, RC2-PCS
<b>BOTTOM CASE</b>	MAGNESIUM
<b>AXLE TYPE</b>	20mm TOOL TYPE/TOOL FREE
<b>FENDER</b>	DETACHABLE INTEGRATED SHORT FENDER

27.5"

29"

38 mm

BOOST

PCS

EQ  
EQUALIZER



RILIX

RIDER ANNA NEWKIRK FINALS 2ND PLACE LOCATION UCI DH1 MARLBOR CUP  
LEOGANG, A PHOTO HOSHI YOSHIDA







## DUROLUX38 / X EXTRA FLOW = EXTRA GO

The DUROLUX38 is the ultimate big-line, enduro fork meant to tame the steepest and rowdiest descents. The DUROLUX38 has all the things you've come to expect from the DUROLUX line like hard 38mm A7000 stanchions, a hollow forged crown, SKF seals, QSP ports and an integrated fender but it now comes in extra juicy with our new extra-flow RC+ Cartridge and semi open oil bath. RC+ has easy rebound and compression adjustability tuned for amazing small bump compliance while still being highly efficient. With extra oil volume flow the RC+ PCS Cartridge can handle the biggest hits even easier with our quickest ever damper response time while keeping composure on the steepest terrain. External low speed compression and rebound adjustment, internal shim based high speed compression and rebound management means less knobs and more control. The RC+ Cartridge was developed by SR SUNTOUR engineers and top professional riders as part of our WERX program. The DUROLUX38 has an improved chassis design with a wider pitch for extra stability and a new 3D machined bushing alignment process for a supple and smooth ride right out of the box. Want even more? Check out the E-Bike version, the DUROLUX38 X , with all of the same features but with extra material and strength for the gnarliest of applications. DUROLUX38, Extra flow means extra go!

<b>MODEL</b>	DUROLUX38, X
<b>INTENDED USE</b>	ENDURO
<b>TRAVEL</b>	160, 170, 180 mm
<b>WHEEL SIZE</b>	29"
<b>SPRING</b>	AIR EQ
<b>CARTRIDGE</b>	RC+ -PCS
<b>BOTTOM CASE</b>	MAGNESIUM
<b>AXLE TYPE</b>	15AH2-110, OPTION 15LH-110
<b>FEATURES</b>	LONG FENDER MOUNT, DETACHABLE INTEGRATED SHORT FENDER, ABS MOUNT OPTION



**SOBA**  
TECHNOLOGY

### SEMIOPEN OIL BATH

Extra juicy for the ultimate suspension experience. SOBA works in conjunction with our RC+ PCS dampers to provide extra lubrication to keep your fork running smoothly, run after run. SOBA ensures that you'll get the right amount of oil to keep moistening the bushings and seals and can be easily refreshed with our lubrication bleed ports.

# DUROLUX



**BOOST**



**DUROLUX38 X  
SPECIAL  
FEATURES**



**E-BIKE  
READY**



ENDURO

DUROLUX38 / X

// 21025

**SUNTOUR**

**DUROLUX**



RIDER: DLAN CRANE. LOCATION: SANTA CRUZ, USA. PHOTO: HOSHI YOSHIDA



## AURON36 TAME ANY TRAIL

The AURON is back and it's bigger and badder than ever! The AURON36 is designed to be the ultimate trail fork, with all the traction and support you need for climbing combined with all the control and playfulness for fun and efficiency on the decent. With stiff 36mm stanchions, an air EQ system and our all new RC+PCS Cartridge with semi open oil bath, you'll be ready for anything the trail can throw at you. Our RC+ cartridge has easy rebound and compression adjustability tuned to give excellent small bump performance and also to be highly efficient. With extra oil volume flow the RC+ PCS Cartridge has excellent small bump compliance along with being super stable. Combine the RC+ cartridge with a stiff chassis and QSP ports you can keep the AURON36 running smoother and longer. The RC+ Cartridge was developed by SR SUNTOUR engineers and top professional riders as part of our WERX program. It's the perfect weapon for trail and All Mountain bikes with 140-160mm of travel. The AURON36 is ready to tame any trail, are you?

<b>MODEL</b>	AURON36
<b>INTENDED USE</b>	TRAIL, ALL MOUNTAIN
<b>TRAVEL</b>	150, 160 MM
<b>WHEEL SIZE</b>	27.5", 29"
<b>SPRING</b>	AIR EQ
<b>CARTRIDGE</b>	RC+ -PCS
<b>BOTTOM CASE</b>	MAGNESIUM
<b>AXLE TYPE</b>	15LH-110, OPTION 20LH-110
<b>FEATURES</b>	LONG FENDER MOUNT, DETACHABLE INTEGRATED SHORT FENDER



**SOBA**  
TECHNOLOGY

### SEMIOPEN OIL BATH

Extra juicy for the ultimate suspension experience. SOBA works in conjunction with our RC+ PCS dampers to provide extra lubrication to keep your fork running smoothly, run after run. SOBA ensures that you'll get the right amount of oil to keep moistening the bushings and seals and can be easily refreshed with our lubrication bleed ports.

# AURON

27.5"

29"

36mm

BOOST

PCS

EQ  
EQUALIZER

HOLLOW  
CROWN

SOBA  
TECHNOLOGY

TRAIL / AM

AURON36

// 21025

SR SUNTOUR



# AUROON

RIDER: SAM BLENKINSOP LOCATION: MOUNT HUTT NZ PHOTO: HOSHI YOSHIDA



**TRIAIR 2**

## TRIAIR2 ESTABLISH TRACTION

Split second reactions to rapidly approaching terrain must be translated smoothly through the bike for the rider to have genuine control. The TRIAIR2 was designed to handle the abuse of long, challenging descents while maintaining consistent damping, holding a steady line. The TRIAIR2 has a reinforced damping setting as well as a new bigger steel shaft for improved mid-stroke support. The redesigned piggyback offers a better oil flow and clearance with more bikes. Also features an air-backed IFP, riders can adjust this as well as easy volume spacer adjustment to dial in the desired spring curve. The 3CR damping allows for 3 position compression adjustment and 8-clicks of rebound range to create the proper balance between fork and shock. TRIAIR2 is QSP designed for reliability and serviceability, and is the perfect match for the DUROLUX, AURON, and AION forks.

<b>MODEL</b>	TRIAIR2
<b>INTENDED USE</b>	ENDURO/TRAIL
<b>FUNCTION</b>	3CR, 2CR, R
<b>SPRING</b>	AIR (AIR VOLUME SPACER, IFP SYSTEM) AIR CAN OPTIONS AVAILABLE
<b>TRAVEL</b>	INCH: 200X51 MM METRIC: 190x37.5 / 40 / 42.5 / 45 MM, 210x47.5 / 50 / 52.5 / 55 MM, 230x57.5 / 60 / 62.5 / 65 MM, 250x67.5 / 70 / 72.5 / 75 MM TRUNNION: 185x47.5 / 50 / 52.5 / 55 MM, 205x57.5 / 60 / 62.5 / 65 MM, 225x67.5 / 70 / 72.5 / 75 MM



E-BIKE  
READY

RIDER PAUL BASAGOTTA LOCATION SANTA CRUZ, USA PHOTO HOSHI YOSHIDA



# TRIAIR 3





# AION

## AION38X A STEP ABOVE

The all-new SR SUNTOUR AION38X is the ultimate all-mountain and hard-charging suspension fork at a price that will leave money left for a few extra shuttle laps or an extra battery. With robust 38mm stanchions and up to 180mm of travel this ebike ready fork goes even harder. Featuring our air EQ system and a sealed PCS damper, it makes for the easiest set-up and adjustments for the hardest and steepest trails. We also didn't skimp on the details as we included integrated fenders, space for big tires and brake rotors, and fender mounting points all in a value-oriented package.

<b>MODEL</b>	AION38 X BOOST EQ
<b>INTENDED USE</b>	TRAIL, ALL MOUNTAIN
<b>TRAVEL</b>	160, 170, 180 mm
<b>WHEEL SIZE</b>	27.5", 29"
<b>SPRING</b>	AIR EQ
<b>CARTRIDGE</b>	3CR-PCS, 2CR-PCS, RC-PCS, LORC-PCS
<b>BOTTOM CASE</b>	MAGNESIUM
<b>AXLE TYPE</b>	15AH2-110, OPTION 15LH-110
<b>FEATURES</b>	TRAIL FENDER, LONG FENDER MOUNTS, ABS MOUNT OPTION

27.5"

29"

36 mm

BOOST

PCS

EQ  
EQUALIZER

ABS

E-BIKE  
READY

X  
eXtra  
strong

TRAIL / AM

AION38X

// 21025

SUNTOUR



RIDER ALBAN AUBERT LOCATION EL HIERRO, SPAIN PHOTO CONSTANTIN FIENE





## ZERON36 / X RIDE MORE, SPEND LESS

The ZERON36 and ZERON36X Air EQ suspension fork offers a blend of lightweight performance and robust durability, all at a value price point making it the perfect upgrade for trail bikes and e-MTBs. Our Air EQ system ensures precise and effortless tuning. 36mm stanchions, an integrated fender, wider tire clearance and compatibility with the biggest brake rotors means your setup is ready for anything.

<b>MODEL</b>	ZERON36 BOOST / X
<b>INTENDED USE</b>	TRAIL, ALL MOUNTAIN
<b>TRAVEL</b>	120, 130, 140, 150, 160 mm
<b>WHEEL SIZE</b>	27.5", 29"
<b>SPRING</b>	AIR EQ
<b>CARTRIDGE</b>	3CR, 2CR, RC
<b>BOTTOM CASE</b>	MAGNESIUM
<b>AXLE TYPE</b>	15AH2-110, OPTION 15LH-110
<b>FEATURES</b>	LONG FENDER MOUNT, DETACHABLE INTEGRATED SHORT FENDER

# ZERON

27.5"

29"

36 mm

BOOST

EQ  
EQUALIZER

ZERON36X  
SPECIAL  
FEATURES

ABS  
MOUNT

E-BIKE  
READY

eXtra  
strong

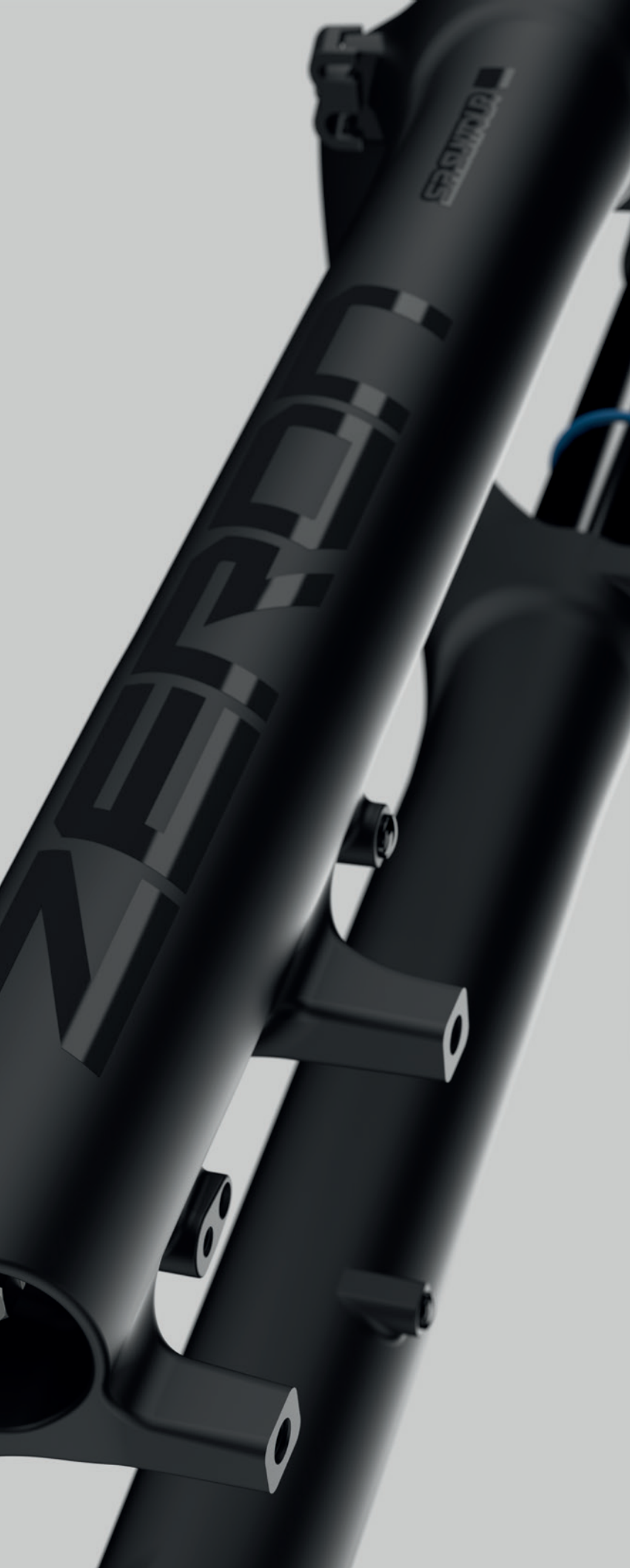

ZEFRON



RIDER: SIMON CHAPELET LOCATION: CROWN PEAK, NZ PHOTO: HOSHI YOSHIDA

# MOBIE36



## MOBIE36 READY FOR EVERYTHING

MOBIE36 delivers E-MTB performance, Urban or Trail, with useful features such as an integrated trail fender, mounts for urban fenders, integrated crown lamp mount on a shade-free high position and ABS for safety and comfort. 36mm stanchions and Boost hub spacing offer accurate and stable steering, excellent control and accommodate wider tires. Our EQ air negative spring makes SAG setting effortless, precise and accommodates a wide range of rider weight, together with sealed PCS dampers, this adds up to the best settings and comfort in any terrain. To achieve the best level of safety, the MOBIE36 accommodates large disc brakes and comes with optional ABS mounting points.

<b>MODEL</b>	MOBIE36 BOOST EQ
<b>INTENDED USE</b>	SPORTS UTILITY
<b>TRAVEL</b>	120, 130, 140, 150 mm
<b>WHEEL SIZE</b>	27.5", 29"
<b>SPRING</b>	AIR EQ
<b>CARTRIDGE</b>	3CR PCS, 2CR PCS, LORC PCS
<b>BOTTOM CASE</b>	MAGNESIUM
<b>AXLE TYPE</b>	15AH2-110, OPTION 15LH-110
<b>FEATURES</b>	LONG FENDER MOUNT, CROWN LAMP MOUNT, ABS AND SENSOR MOUNT



E-BIKE  
READY

LOCATION FREIBURG, GERMANY PHOTO JORDI MOLLELLEDA



NOBI 36





## AXON34 WERX BEYOND XC

When every position matters, whether it's at the front end of an XC race or setting a PR on your local track, the AXON Werx is the weapon of choice. The AXON Werx has seen success at the highest levels of competition, recently winning Olympic Gold and taking the top step at many World Cup events under some of the most impressive athletes in the world. The demands of XC racing are grueling, to succeed requires precision, control and consistency. The AXON34 Werx is in a league of its own, having a one-piece hollow carbon upper and 34mm stanchions that maximize stiffness while maintaining a proper race weight. The new Air EQ System perfectly balances the positive and negative air chamber for exact support and excellent performance for each individual rider and weight. The PCS cartridge and EQ air system combine to give supple small bump compliance while maintaining proper support. All of this in a package that is easy to maintain and service with our QSP philosophy, means you'll be on the trail more and in the shop less.

<b>MODEL</b>	AXON34 WERX
<b>INTENDED USE</b>	CROSS COUNTRY
<b>TRAVEL</b>	100, 110, 120mm
<b>WHEEL SIZE</b>	29"
<b>SPRING</b>	AIR EQ
<b>CARTRIDGE</b>	RLRC-PCS
<b>UPPER</b>	ONE PIECE HOLLOW CARBON
<b>BOTTOM CASE</b>	MAGNESIUM
<b>AXLE TYPE</b>	15QLC2TI-110
<b>FENDER</b>	DETACHABLE INTEGRATED SHORT FENDER



BOOST



EQUALIZER

EQUALIZER

EQUALIZER

EQUALIZER

EQUALIZER

EQUALIZER

EQUALIZER

EQUALIZER

EQUALIZER

EQUALIZER

EQUALIZER

EQUALIZER

EQUALIZER

EQUALIZER

EQUALIZER

EQUALIZER

EQUALIZER

EQUALIZER

EQUALIZER

EQUALIZER

EQUALIZER

EQUALIZER

EQUALIZER

EQUALIZER

EQUALIZER

EQUALIZER

EQUALIZER

EQUALIZER

EQUALIZER

EQUALIZER

EQUALIZER

EQUALIZER

EQUALIZER

EQUALIZER

EQUALIZER

EQUALIZER

EQUALIZER

EQUALIZER

EQUALIZER

EQUALIZER

EQUALIZER

EQUALIZER

EQUALIZER

EQUALIZER

EQUALIZER

EQUALIZER

EQUALIZER

EQUALIZER

EQUALIZER

EQUALIZER

EQUALIZER

EQUALIZER

EQUALIZER

EQUALIZER

EQUALIZER

EQUALIZER

EQUALIZER

EQUALIZER

EQUALIZER

EQUALIZER

EQUALIZER

EQUALIZER

EQUALIZER

EQUALIZER

EQUALIZER

EQUALIZER

EQUALIZER

EQUALIZER

EQUALIZER

EQUALIZER

EQUALIZER

EQUALIZER

EQUALIZER

EQUALIZER

EQUALIZER

EQUALIZER

EQUALIZER

EQUALIZER

EQUALIZER

EQUALIZER

EQUALIZER

EQUALIZER

EQUALIZER

EQUALIZER

EQUALIZER

EQUALIZER

EQUALIZER

EQUALIZER

EQUALIZER

EQUALIZER

EQUALIZER

EQUALIZER

EQUALIZER

EQUALIZER

EQUALIZER

EQUALIZER

EQUALIZER

EQUALIZER

EQUALIZER

EQUALIZER

EQUALIZER

EQUALIZER

EQUALIZER

EQUALIZER

EQUALIZER

EQUALIZER

EQUALIZER

EQUALIZER



FLYXOR

RIDER: TOM PIDCOCK LOCATION: WC NOVE MESTO, CZ PHOTO: ANY VATHIS



# edge



## EDGE X - FOR LIVING LIFE ON THE EDGE

From modern XC racing to technical trail riding you demand damping performance for the most efficient yet comfortable ride. The EDGE was created to perform as a lightweight and fast forward moving XC racing shock, featuring adjustable compression and rebound damping for a custom, controlled ride. The EDGE X is the latest addition to our growing family. While the EDGE name remains synonymous for short to mid-travel bikes, the X indicates a reinforced and updated structure dealing with the demands modern full suspension ebikes are bringing to the table. Coming in an overhauled and refreshed design, the new EDGE X features a redesigned shaft delivering extra strength right out of the core with improved sliding behavior that creates excellent small bump compliance under heavier loads and stress. This is also supported by a larger negative air chamber to create a smooth ride off the top while delivering the desired support. While we've prioritized comfort, the efficiency of the EDGE X reigns supreme. The efficiency is supported by an increased amount of mid-stroke support when paired with precise rebound damping gives you a calmer ride all while keeping the focus on the forward movement. Historically XC racing bikes have used a full lockout but for the modern full suspension ebike we've developed a firm switch, giving efficiency, but leaving the right amount of travel for the comfortable ride and ultimate traction. So choose the X and go for an Ohh!

<b>MODEL</b>	EDGE X
<b>INTENDED USE</b>	URBAN / XC / TRAIL
<b>FUNCTION</b>	2CR, RC, R
<b>SPRING</b>	AIR, ADJUSTABLE VOLUME AIR CAN OPTIONS AVAILABLE
<b>TRAVEL</b>	INCH: 152x31 MM, 165x38 MM, 184x44 MM METRIC: 70x27.5 / 30 / 32.5 / 35 MM, 190x37.5 / 40 / 42.5 / 45 MM, 210x47.5 / 50 / 52.5 / 55 MM TRUNNION: 145x27.5 / 30 / 32.5 / 35 MM, 165x37.5 / 40 / 42.5 / 45 MM, 185x47.5 / 50 / 52.5 / 55 MM



E-BIKE  
READY



eXtra  
strong



edge

RIDER ALBAN AUBERT LOCATION ST GOTTHARD PASS SWISS PHOTO PETER VROONEN







**edge<sup>EVO</sup>**

## **EDGE EVO THE INLINE ANSWER**

Our most robust and advanced inline shock yet the EDGE Evo is the ultimate in control and durability, in a tidy, lightweight package. The perfect shock for XC, Trail and all bikes in between, you can trust the EDGE Evo when you're punching it at max speed down the fastest sections and have all the support you need to get you back up the trail as efficiently as possible. We've made everything inside smoother and stiffer, while also adding a bunch of air volume so you can precisely tune the ride feel. The EDGE Evo has two different air can shapes available to fine tune your ride even more all with 2 or 3 stage compression and a full round of rebound adjustment. Available in modern sizes and optional trunnion mounts this shock will fit metric sizes between 37.5-65 mm of stroke. Easy to set up, easy to use and easy to maintain as part of our QSP philosophy.

<b>MODEL</b>	EDGE EVO
<b>INTENDED USE</b>	XC, TRAIL, ALL MOUNTAIN
<b>FUNCTION</b>	R-2CR, 2CR, R
<b>SPRING</b>	AIR, ADJUSTABLE VOLUME AIR CAN OPTIONS AVAILABLE
<b>TRAVEL</b>	INCH: 200x51 MM METRIC: 190x37.5 / 40 / 42.5 / 45 MM, 210x47.5 / 50 / 52.5 / 55 MM, 230x57.5 / 60 / 62.5 / 65 MM TRUNNION: 165x37.5 / 40 / 2.5 / 45 MM, 185x47.5 / 50 / 52.5 / 55 MM, 205x57.5 / 60 / 62.5 / 65 MM



**E-BIKE  
READY**

XC / TRAIL / AM

EDGE EVO

// 2125

**SR SUNTOUR**

RIDER DEVIN TOLLESON LOCATION SANTA CRUZ CA, USA PHOTO HOSHI YOSHIDA



**edge**<sup>EVO</sup>





# RAIDON 34

20"

24"

27.5"

29"

34 mm

BOOST

EQU  
EQUALIZER

RAIDON34X  
SPECIAL  
FEATURES

E-BIKE  
READY

eXtra  
strong

XC / TRAIL

RAIDON34X & JR

// 21025

SFSAUTOUR



# RAIDON 34

## **RAIDON34X & JR FUN FOR BOTH - KIDS AND ADULTS**

The RAIDON has been part of our lineup for as long as we can remember. It has always been the epitome of the best value for the money for XC and trail riding and that still holds true in its current iteration. The newest RAIDON is even ebike ready and together with our EQ system, the adjustability is even easier, more precise and more powerful. The integrated trail mudguard keeps the view clear and the long fender mounts can be used to optimize the setup for everyday use. A PCS-backed sealed cartridge and 34mm stanchions complete the package to deliver excellent control quality and stability. Kids also love the RAIDON Jr models to fit smaller bikes and wheel sizes so everyone can hit the trails together.



---

<b>MODEL</b>	RAIDON34 X, RAIDON34 BOOST JR
<b>INTENDED USE</b>	XC, TRAIL
<b>TRAVEL</b>	80, 100, 120mm, JR: 100, 120mm
<b>WHEEL SIZE</b>	29", 27.5", JR: 20" & 24"
<b>SPRING</b>	AIR, JR: AIR EQ
<b>CARTRIDGE</b>	2CR, R-2CR, JR: 2CR
<b>BOTTOM CASE</b>	MAGNESIUM
<b>AXLE TYPE</b>	15AH2-110, OPTION 15LH-110 JR: 15AH2-110, OPTION 15LH-110
<b>FEATURES</b>	TRAIL FENDER, LONG FENDER MOUNT



GVX

## GVX - ROADS OR NOT ROADS

The SR SUNTOUR GVX is an excellent choice for gravel enthusiasts seeking a balance of performance, comfort, and versatility all at a killer value. With an EQ air spring, PCS sealed damping cartridge with lockout, 7000 series lightweight aluminum stanchions and hollow crown the GVX is poised to become a favorite in the gravel riding community. Whether you're an adventure rider or a competitive racer, the GVX's innovative design and robust construction promise a superior riding experience. Less fatigue and more control for those all day gravel epics or when you have no idea what the "roads" will be like.

<b>MODEL</b>	GVX32 S
<b>INTENDED USE</b>	GRAVEL
<b>TRAVEL</b>	40, 50, 60 mm
<b>WHEEL SIZE</b>	700C
<b>STANCHIONS</b>	A7000SERIES ALUMINUM (GVX32 S)
<b>SPRING</b>	AIR EQ
<b>CARTRIDGE</b>	LOR PCS, RLR PCS
<b>BOTTOM CASE</b>	MAGNESIUM
<b>AXLE TYPE</b>	15AH2, OPTION 12AH
<b>FEATURES</b>	HOLLOW CROWN, DETACHABLE INTEGRATED SHORT FENDER, LONG FENDER MOUNT



SAVAGE

RIDER DAVID CACHÓN LOCATION BARDENAS REALES, SPAIN PHOTO DAVID PONCE





# SR SUNTOUR E-BIKE SYSTEM

## YOUR DRIVING FORCE

Power, Dynamic, Range; the full extent of what is possible for bicycles is ever increasing, evidenced by the advent of pedal-assist.

SR SUNTOUR's history of innovation and forward-thinking is long and well established. Developments within our E-Bike systems push the realms of possibility beyond the known. It is a time of uncharted exploration for bicycles.

The Top Drive freewheel function enables the rider to maintain steady, consistent motion with or without assistance, achieving the accustomed feel of a freehub. The rear-hub motor provides direct power to the rear-wheel, leading to the active feel without compromises in shifting performance.

Our core philosophy of QSP (Quick Service Product) is a significant aspect of the E-bike system. The maintenance in mind design allows dealers, mechanics and riders ease of service and troubleshooting. Synchronizing the utilization of components simplifies both assembly and access, reducing service time, which in turn means more ride-time. The SR SUNTOUR E-Bike System is refined simplicity for the evolving world of E-bikes.



### TOP DRIVE TECHNOLOGY

100% freewheel effect in any situation - even beyond electric support.



### QUICK SERVICE PRODUCT

Simple construction and service for uninterrupted performance and longevity.



<b>MODEL</b>	R250 HP
<b>AXLE</b>	THREADED AXLE
<b>MAX. TORQUE</b>	60NM
<b>POWER NOMINAL</b>	250W
<b>POWER MAX.</b>	450W
<b>SPEED</b>	7-11 SPEED SHIMANO COMPATIBLE
<b>SYSTEM VOLTAGE</b>	36V DC
<b>WEIGHT</b>	3200g

<b>MODEL</b>	F250 HP
<b>AXLE</b>	THREADED AXLE
<b>MAX. TORQUE</b>	40NM
<b>POWER NOMINAL</b>	250W
<b>POWER MAX.</b>	400W
<b>SYSTEM VOLTAGE</b>	36V DC
<b>WEIGHT</b>	2300g





MØST

PINARELLO

1  
SCOTLAND

PIRELLON

EDITION

# GLOSSARY SUSPENSION FORK

## OVERVIEW

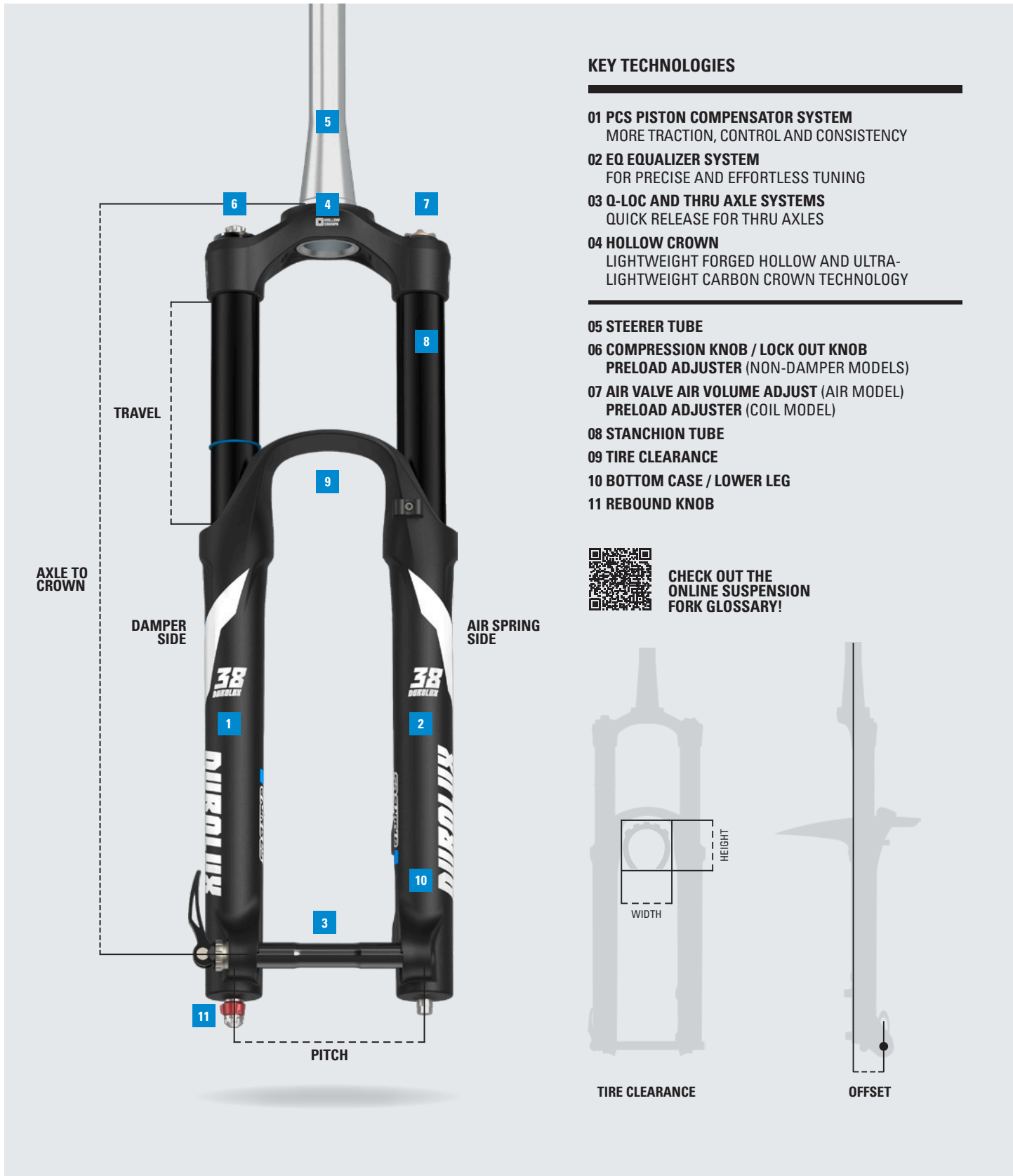

### KEY TECHNOLOGIES

- 01 PCS PISTON COMPENSATOR SYSTEM**  
MORE TRACTION, CONTROL AND CONSISTENCY
- 02 EQ EQUALIZER SYSTEM**  
FOR PRECISE AND EFFORTLESS TUNING
- 03 Q-LOC AND THRU AXLE SYSTEMS**  
QUICK RELEASE FOR THRU AXLES
- 04 HOLLOW CROWN**  
LIGHTWEIGHT FORGED HOLLOW AND ULTRA-LIGHTWEIGHT CARBON CROWN TECHNOLOGY
- 05 STEERER TUBE**
- 06 COMPRESSION KNOB / LOCK OUT KNOB**  
PRELOAD ADJUSTER (NON-DAMPER MODELS)
- 07 AIR VALVE AIR VOLUME ADJUST (AIR MODEL)**  
PRELOAD ADJUSTER (COIL MODEL)
- 08 STANCHION TUBE**
- 09 TIRE CLEARANCE**
- 10 BOTTOM CASE / LOWER LEG**
- 11 REBOUND KNOB**



CHECK OUT THE  
ONLINE SUSPENSION  
FORK GLOSSARY!

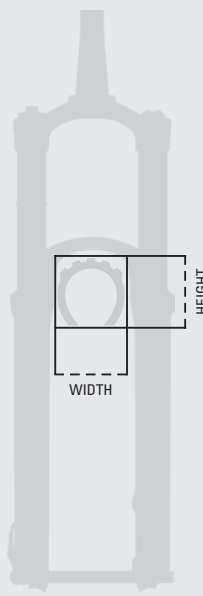

TIRE CLEARANCE



OFFSET

# EQ EQUALIZER SYSTEM

FOR PRECISE & EFFORTLESS AIR SPRING TUNING



WATCH THE  
DUROLUX EQ  
VIDEO

LEARN MORE AT [WWW.SRSUNTOUR.COM/EQ](http://WWW.SRSUNTOUR.COM/EQ)

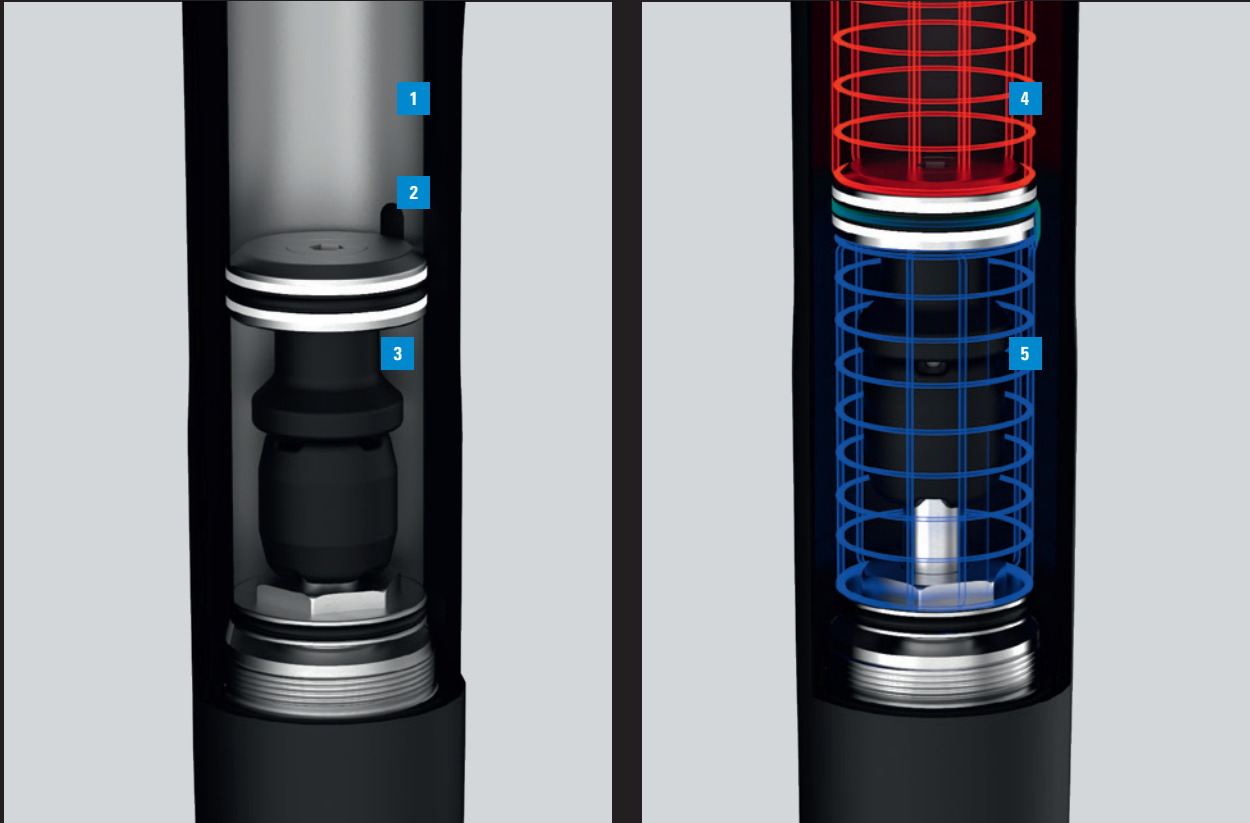

- 1 Positive air chamber
- 2 Transfer port
- 3 Negative air Chamber
- 4 Positive air pressure
- 5 Negative air pressure

**SET YOUR SAG AND THE EQUALIZER (EQ) AIR NEGATIVE SPRING SYSTEM WILL BALANCE IT FOR YOU.**

Our tradition of product evolution brings our forks into a brand new era with our EQ air system. The EQ system perfectly balances positive and negative spring independent from rider weight, which results in amazing performance and precise support across the range. This customizes feel for each individual rider optimizing SAG and volume control. Pairing the EQ system with the external damping adjustments of our PCS cartridges promise a supple coil spring feel in a lightweight, progressive and easy to adjust air spring package. You can set your SAG according to your intended riding style

and the EQ system will balance it with the right amount of negative spring force helping you to create a precise and effortless tune. The EQ system will improve fork sensitivity of small repetitive bumps while providing plenty of mid-stroke support for those bigger hits resulting in enhanced comfort and performance when riding any kind of terrain.

**FUNCTIONAL FEATURES**

- Greater, automatic spring adjustability based on the riding style and weight of the rider
- Improved fork sensitivity for those small but fast repetitive bumps
- Super consistent damping performance in tandem with the PCS system

# PCS – PISTON COMPENSATOR SYSTEM

*MORE TRACTION, CONTROL AND CONSISTENCY*



WATCH THE  
PCS VIDEO

LEARN MORE AT [WWW.SRSUNTOUR.COM/PCS](http://WWW.SRSUNTOUR.COM/PCS)

## LOW SPEED COMPRESSION



## HIGH SPEED COMPRESSION

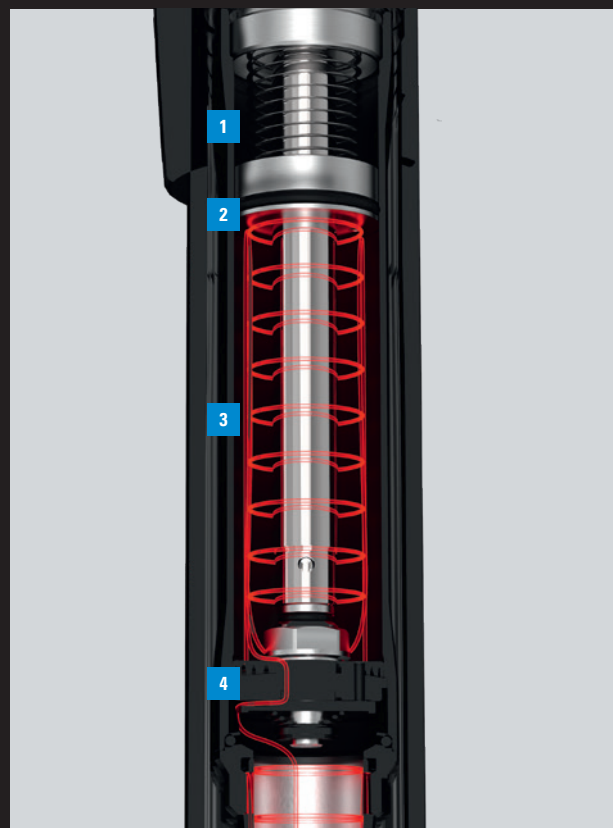

- 1 Air
- 2 PCS avoids vacuum effect
- 3 Oil (Red and blue marked area)
- 4 Piston management of high / low speed compression

### THE ULTIMATE IN TRACTION, CONTROL AND CONSISTENCY

With over 20 years of refinement, SR Suntour's Cartridge Science Program has created the most controlled, consistent and functional dampers we've ever produced. PCS is a simple and repeatable way of reducing cavitation (air and oil mixing and creating pressure). Less cavitation means more predictable damping performance, and with cartridges being tested to over 200,000 cycles that performance should last run after run, ride after ride. When it does need servicing, our Quick Service Product (QSP) Philosophy, ensures that you'll spend less time in the work stand and more time on the trail.

### 3CR PCS

With easy 3-position compression adjustment you can go from open to mid to firm at the touch of a lever. Backed with our PCS system to reduce cavitation you can instantly tune your ride to the terrain. Open: Supportive but ready for big hits, varying terrain and downhills Mid: Extra support for hard charging, technical climbing and undulating terrain Firm: Efficient pedaling for roads, smooth climbing and big sprints.

### 2CR PCS

Take all the guesswork out of your suspension with easy 2 position on-the-fly adjustment. Whether you choose the fully open position to tame the terrain or the firm position for the utmost in pedaling efficiency the 2CR PCS cartridge has you covered.

# PCS CARTRIDGES

## RC+-PCS



**INTERNAL SHIM BASED HIGH SPEED COMPRESSION AND REBOUND MANAGEMENT**  
**EXTERNAL LOW SPEED COMPRESSION & REBOUND ADJUST**  
**PCS SYSTEM (PISTON COMPENSATOR SYSTEM)**

Race proven WERX cartridge with PCS (Piston Compensator system) floating piston provides consistent damping in all conditions, eliminating cavitation

- Extra oil flow for high speeds and hard impacts while still offering excellent performance for both small bumps and trail chatter
- High and low speed circuit work independent but transition seamlessly into each other.
- Forged alloy adjust knobs with integrated design
- Updated internal seals greatly improve durability for Trail/AM and Enduro usage
- Light "Click" index feeling for easy and sure operation



## R2C2-PCS



**HIGH AND LOW SPEED COMPRESSION ADJUST**  
**HIGH AND LOW SPEED REBOUND**  
**PCS SYSTEM (PISTON COMPENSATOR SYSTEM)**

Race proven WERX cartridge with PCS (Piston Compensator system) floating piston provides consistent damping in all conditions, eliminating cavitation

- High speed compression piston provides a larger adjustable range
- Adjustable high speed rebound design provides fast recovery for improved ride height position
- Updated internal seals greatly improve durability for Trail, Enduro and DH riding
- Forged alloy adjust knobs with integrated design
- Light "Click" index feeling for easy and sure operation

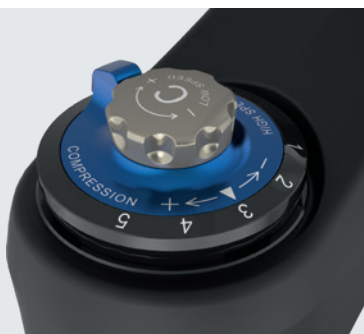

## RC2-PCS



**HIGH AND LOW SPEED COMPRESSION ADJUST**  
**REBOUND ADJUST**  
**PCS SYSTEM (PISTON COMPENSATOR SYSTEM)**

Race proven WERX cartridge with PCS (Piston Compensator system) floating piston provides consistent damping in all conditions, eliminating cavitation

- High speed compression piston provides a larger adjustable range
- Updated internal seals greatly improve durability for Trail, Enduro and DH riding
- Forged alloy adjust knobs with integrated design
- Light "Click" index feeling for easy and sure operation



## RC-PCS



**LOW SPEED COMPRESSION  
ADJUST  
REBOUND ADJUST  
PCS SYSTEM  
(PISTON COMPENSATOR  
SYSTEM)**

Race proven WERX cartridge with PCS (Piston Compensator system) floating piston provides consistent damping in all conditions, eliminating cavitation

- Updated internal seals greatly improve durability for Trail, Enduro and DH riding
- Forged alloy adjust knobs with integrated design
- Light "Click" index feeling for easy and sure operation



## R-3CR-PCS



**3 POSITIONS OF  
COMPRESSION ADJUST  
LOW SPEED REBOUND ADJUST  
REMOTE LOCK OUT  
PCS SYSTEM (PISTON  
COMPENSATOR SYSTEM)**

Race proven WERX cartridge with PCS (Piston Compensator system) floating piston provides consistent damping in all conditions, eliminating cavitation

- Remote actuated 3 step (firm, medium, open) low speed compression adjustment. Low speed rebound damping adjust
- Forged alloy adjust knobs with integrated design
- Ergonomic design remote lock lever for faster and easier operation



## R-2CR-PCS



**2 POSITIONS OF  
COMPRESSION ADJUST  
LOW SPEED REBOUND ADJUST  
REMOTE LOCK OUT  
PCS SYSTEM (PISTON  
COMPENSATOR SYSTEM)**

Race proven WERX cartridge with PCS (Piston Compensator system) floating piston provides consistent damping in all conditions, eliminating cavitation

- Remote actuated 2 step (firm, open) low speed compression adjustment. Low speed rebound damping adjust
- Forged alloy adjust knobs with integrated design
- Ergonomic design remote lock lever for faster and easier operation





## 2CR-PCS

### 2 POSITIONS OF COMPRESSION ADJUST LOW SPEED REBOUND ADJUST PCS SYSTEM (PISTON COMPENSATOR SYSTEM)

Race proven WERX cartridge with PCS (Piston Compensator system) floating piston provides consistent damping in all conditions, eliminating cavitation

- 2 step (firm, open) low speed compression adjustment. Low speed rebound damping adjust
- Updated internal seals greatly improve durability for Trail, Enduro riding
- Light "Click" index feeling for easy and sure operation



## 3CR-PCS

### 3 POSITIONS OF COMPRESSION ADJUST LOW SPEED REBOUND ADJUST PCS SYSTEM (PISTON COMPENSATOR SYSTEM)

Race proven WERX cartridge with PCS (Piston Compensator system) floating piston provides consistent damping in all conditions, eliminating cavitation

- 3 step (firm, medium, open) low speed compression adjustment. Low speed rebound damping adjust.
- Updated internal seals greatly improve durability for Trail, Enduro and DH riding
- Light "Click" index feeling for easy and sure operation



## RLRC-PCS

### LOW SPEED COMPRESSION ADJUST REBOUND ADJUST REMOTE SPEED LOCK PCS SYSTEM (PISTON COMPENSATOR SYSTEM)

Race proven WERX cartridge with PCS (Piston Compensator system) floating piston provides consistent damping in all conditions, eliminating cavitation

- 3 in 1 function: Lock out, low speed compression adjust & rebound adjust in one cartridge.
- Drastic improvement of riding efficiency & its adjustability for cross country & trail ride
- Forged alloy adjust knobs with integrated design
- Updated internal seals greatly improve durability for Trail, Enduro and DH riding
- Light "Click" index feeling for easy and sure operation
- Ergonomic design remote lock lever for faster and easier operation



## RLR-PCS



**REBOUND ADJUST  
REMOTE SPEED LOCK  
PCS SYSTEM (PISTON  
COMPENSATOR SYSTEM)**

Race proven WERX cartridge with PCS (Piston Compensator system) floating piston provides consistent damping in all conditions, eliminating cavitation

- Hydraulic Remote Lockout
- Drastic improvement of riding efficiency & its adjustability for cross country & trail ride
- Forged alloy adjust knobs with integrated design
- Updated internal seals greatly improve durability for Trail, Enduro and DH riding
- Light "Click" index feeling for easy and sure operation



## LORC-PCS



**LOW SPEED COMPRESSION  
ADJUST  
REBOUND ADJUST  
SPEED LOCK  
PCS SYSTEM (PISTON  
COMPENSATOR SYSTEM)**

Race proven WERX cartridge with PCS (Piston Compensator system) floating piston provides consistent damping in all conditions, eliminating cavitation

- 3-in-1 Lock out + low speed compression & rebound adjust in one cartridge
- Drastic improvement of riding efficiency & its adjustability for cross country & trail ride
- Forged alloy adjust knobs with integrated design
- Updated internal seals greatly improve durability for Trail, Enduro and DH riding
- Light "Click" index feeling for easy and sure operation

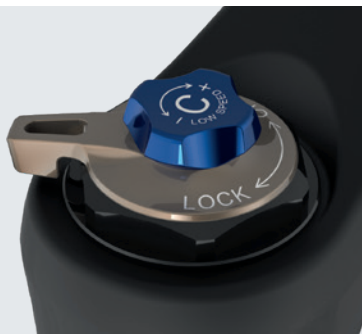

## LOR-PCS



**2 POSITIONS OF  
COMPRESSION ADJUST  
LOW SPEED REBOUND  
ADJUST  
PCS SYSTEM (PISTON  
COMPENSATOR SYSTEM)**

Race proven WERX cartridge with PCS (Piston Compensator system) floating piston provides consistent damping in all conditions, eliminating cavitation

- Hydraulic Lockout with adjustable rebound damping with blow off feature.
- Forged alloy adjust knobs with integrated design
- Updated internal seals greatly improve durability for Trail, Enduro and DH riding
- Light "Click" index feeling for easy and sure operation



# DAMPING ADJUSTMENT



RC+



R2CR-PCS



RC2-PCS

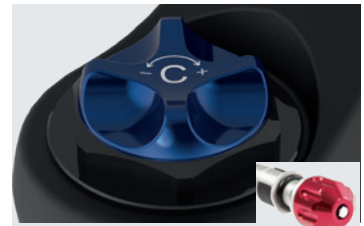

RC-PCS



R-3CR-PCS



R-2CR-PCS



3CR-PCS



2CR-PCS



2CR-PCS



RLRC-PCS



RLR-PCS



LORC-PCS



LOR-PCS



2CR



2CR



2CR

NAME	FUNCTION
RC+	External low speed compression and rebound adjustment, internal shim based high speed compression and rebound management.
R2CR-PCS	High & low speed compression and high & low speed rebound damping adjusts with blow-off feature along with PCS system.
RC2-PCS	High & low speed compression and low speed rebound damping adjusts with blow-off feature along with PCS system.
RC-PCS	Low speed compression and low speed rebound damping adjusts with blow-off feature along with PCS system.
R-3CR-PCS	Remote Lockout with 3 positions of compression (firm setting, medium setting and open setting) with low speed rebound adjust along with PCS system.
R-2CR-PCS	Remote Lockout with 2 positions of compression (firm setting and open setting) with low speed rebound adjust along with PCS system.
3CR-PCS	3 positions of compression (firm setting, medium setting and open setting) with low speed rebound adjust along with PCS system.
2CR-PCS	2 positions of compression (firm setting and open setting) with low speed rebound adjust along with PCS system.
RLRC-PCS	Hydraulic Remote Lockout with low speed compression and low speed rebound damping adjusts with blow-off feature along with PCS system.
RLR-PCS	Hydraulic Remote Lockout with rebound damping adjusts with blow-off feature along with PCS system.
LORC-PCS	Hydraulic Lockout with low speed compression and low speed rebound damping adjusts with blow-off feature along with PCS system.
LOR-PCS	Hydraulic Lockout with adjustable rebound damping with blow-off feature along with PCS system.

NAME	FUNCTION
RC2	High & low speed compression and low speed rebound damping adjusts with blow-off feature.
RC	Low speed compression and low speed rebound damping adjusts with blow-off feature.
3CR	3 position of compression (firm setting, medium setting and open setting) with low speed rebound adjust.
2CR	2 positions of compression (firm setting and open setting) with low speed rebound adjust.
RLRC	Hydraulic Remote Lockout with adjustable rebound and compression damping with blow-off feature.
LORC	Hydraulic Lockout with adjustable rebound and compression damping with blow-off feature.
RLR	Hydraulic Remote Lockout with adjustable rebound damping with blow-off feature.
LOR	Hydraulic Lockout with adjustable rebound damping with blow-off feature.
RL	Hydraulic Remote Lockout with fixed rebound damping with blow-off feature.
LO	Hydraulic Lockout with fixed rebound damping with blow-off feature.
NLO	Hydraulic Lockout with fixed rebound damping.
HLO	Hydraulic Lockout without rebound damping.

<sup>1</sup> SF22-MOBIE35-BOOST-EQ-2CR-PCS-27.5/29", <sup>2</sup> SF23-RAIDON34-BOOST-2CR-27.5/29" / SF23-XCR34-BOOST-COIL-2CR-27.5/29" / SF23-XCR34-BOOST-AIR-2CR-27.5/29" <sup>3</sup> SF21-MOBIE34-D-2CR-27.5/700C

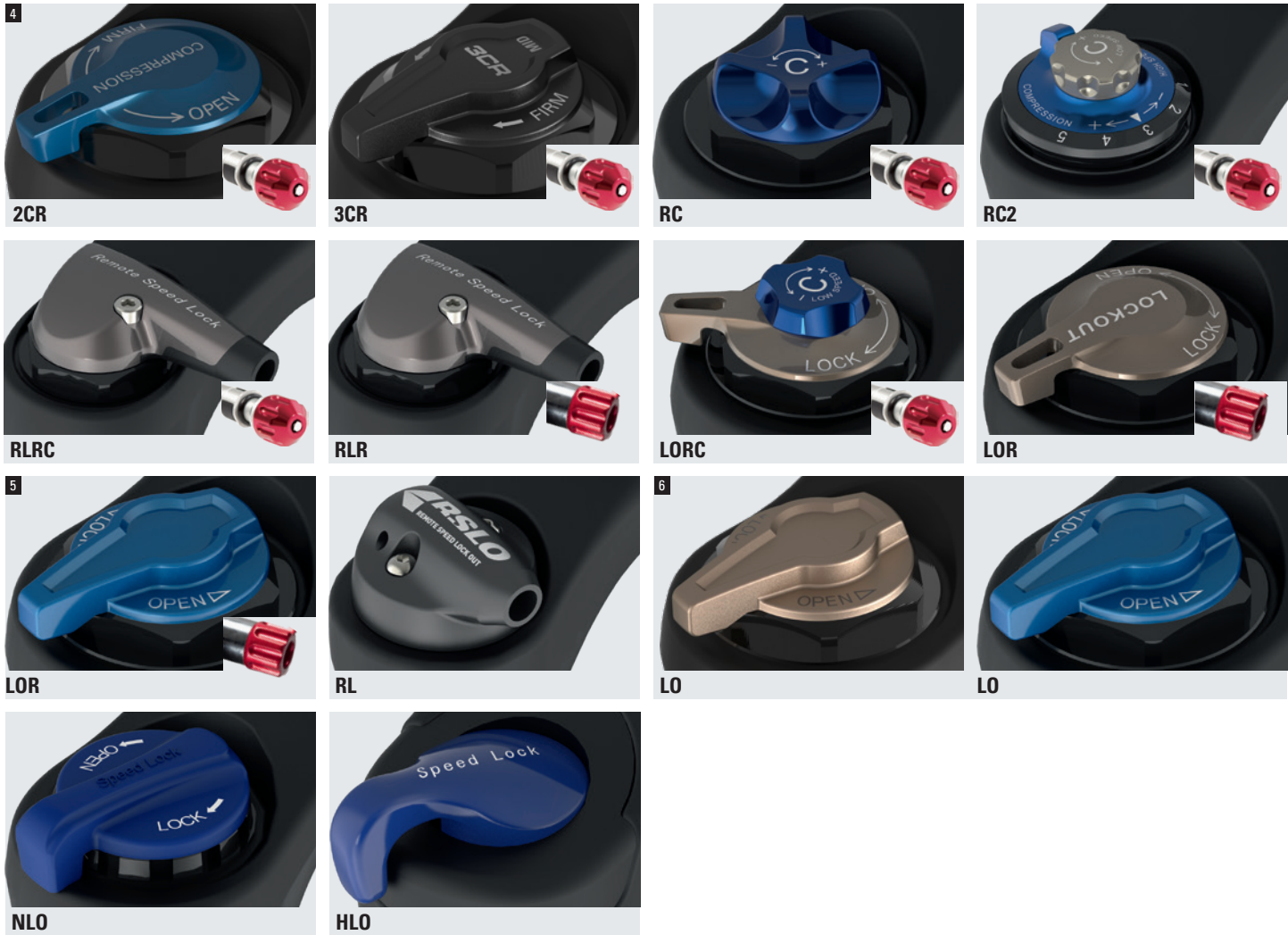

APPLICATION TABLE	RC+	R2C2	RC2	3CR	2CR	RC	R-3CR	R-2CR	RLRC	LORC	RLR	LOR	RL	LO	HLO	NLO
RUX	-	●	●	-	-	-	-	-	-	-	-	-	-	-	-	-
DUROLUX	●	●	●	-	-	●	-	-	-	-	-	-	-	-	-	-
AURON	●	-	-	-	-	-	-	-	-	-	-	-	-	-	-	-
AION	-	-	-	●	●	●	-	-	-	●	-	-	-	-	-	-
ZERON	-	-	-	●	●	●	-	-	-	-	●	●	-	-	-	-
AXON	-	-	-	-	-	-	-	-	●●	●●	-	-	-	-	-	-
RAIDON	-	-	-	-	●	-	-	●	-	-	●	●	-	-	-	-
XCR	-	-	-	-	●	-	-	●	-	-	●	●	●	●	-	-
EIXON32	-	-	-	-	●	-	-	●	-	-	-	-	-	-	-	-
X1	-	-	-	-	-	-	-	-	-	-	●	●	●	●	●	-
XCM	-	-	-	-	-	-	-	-	-	-	-	●	●	●	●	●
XCT	-	-	-	-	-	-	-	-	-	-	-	-	●	●	●	●
MOBIE36	-	-	-	●	●	-	-	-	-	●	-	-	-	-	●	●
MOBIE35	-	-	-	●	●	-	-	-	-	-	-	-	-	-	-	-
MOBIE34	-	-	-	-	●●	-	-	●●	-	-	-	-	-	-	-	-
MOBIE34 CGO	-	-	-	-	-	-	-	-	-	-	-	-	-	●	-	-
MOBIE25	-	-	-	-	-	-	-	-	-	-	●	●	-	-	-	-
MOBIEA32	-	-	-	-	-	-	-	-	-	-	-	-	●	●	-	●
GVX	-	-	-	-	-	-	-	-	-	-	●●	●●	-	-	-	-
NRX	-	-	-	-	-	-	-	-	-	-	●	●	-	-	-	-
NCX32/NCX	-	-	-	-	-	-	-	-	-	-	-	-	●	●	-	-
NX1/TR-HSI	-	-	-	-	-	-	-	-	-	-	-	-	●	●	●	-
NVX	-	-	-	-	-	-	-	-	-	-	-	-	●	-	-	●
NEX	-	-	-	-	-	-	-	-	-	-	-	-	●	-	●	●
CR85	-	-	-	-	-	-	-	-	-	-	-	-	-	●	-	-

● PCS CARTRIDGE

\* SF21MOBIE34-2CR-27.5"/700C, \* SF19-XCR32-BOOST-COIL-LOR 27.5"/29" / SF19-XCR32-BOOST-AIR-LOR 27.5"/29" / SF18-XCR34-BOOST-COIL-LOR 27.5"/29" / SF18-XCR34-BOOST-AIR-LOR 27.5"/29" / SF19-RAIDON32-BOOST-LOR 27.5"/29" / SF18-RAIDON34-BOOST-LOR 27.5"/29", \* SF19-XCR32-BOOST-COIL-LO-27.5"/29" / SF19-XCR32-BOOST-AIR-LO-27.5"/29" / SF18-XCR34-BOOST-COIL-LO-27.5"/29" / SF18-XCR34-BOOST-AIR-LO-27.5"/29"

# SPRING SYSTEM



**AIR EQ (1) / AIR(2)**  
Dual air spring system / Standard air spring



**AIR EQ (3) / AIR (4)**  
Dual air spring system / Standard air spring



**AIR EQ (5)**  
Dual air spring system



**AIR EQ (6) / AIR(7)**  
Dual air spring system / Standard air spring



**COIL ADJUSTABLE**  
Coil spring with adjustable preload



**COIL**  
Coil spring

APPLICATION TABLE	AIR EQ (1)	AIR (2)	AIR EQ (3)	AIR (4)	AIR EQ (5)	AIR EQ (6)	AIR (7)	COIL ADJUSTABLE	COIL
RUX	-	-	●	-	-	-	-	-	-
DUROLUX	●	-	-	-	●	-	-	-	-
AURON	●	-	-	-	-	-	-	-	-
AION	-	-	-	-	●	-	-	-	-
ZERON	-	-	-	-	●	-	-	●	-
AXON	-	●	●	-	-	-	-	-	-
RAIDON	-	-	-	-	-	●	●	-	-
XCR	-	-	●	-	-	-	●	●	-
EPIXON32	-	-	-	-	-	-	●	-	-
X1	-	-	-	-	-	-	●	●	-
XCM	-	-	-	-	-	-	-	●	-
XCT	-	-	-	-	-	-	-	●	-
XCE	-	-	-	-	-	-	-	●	-
M3010	-	-	-	-	-	-	-	●	●
MOBIE36	-	-	-	-	●	-	-	-	-
MOBIE35	-	-	-	-	●	-	-	-	-
MOBIE34/25	-	-	-	●	●	-	●	●	-
MOBIEA32	-	-	-	-	-	-	-	●	-
GVX	-	-	●	-	-	-	-	-	-
NRX	-	-	-	-	-	-	-	●	-
NCX32/NCX	-	-	-	-	-	-	-	●	-
NX1/TR-HSI	-	-	-	-	-	-	-	●	-
NVX	-	-	-	-	-	-	-	●	-
NEX	-	-	-	-	-	-	-	●	-
CR85	-	-	-	-	-	-	-	●	-

# ADJUSTABLE AIR CHAMBER VOLUME

## VOLUME SPACER LOGIC

Adjust your spring curve by using different amounts of rubber volume spacers. This function allows the rider to choose between a more linear or a more progressive air spring curve. More spacers for more progression, less spacers for a more linear feel. Visit [www.srsuntour.com](http://www.srsuntour.com) for tech videos and product manuals with detailed information.

Our air spring curve is widely adjustable with minimal tools, which can then be easily tuned for the proper ride feel for the rider's weight or riding style.



### EXAMPLE FOR SPACER SETUP

RIDING STYLE	RIDER WEIGHT Pressure 25% Sag	55-65 Kg 55 PSI	65-75 Kg 65 PSI	75-85 Kg 75 PSI
	Aggressive			
Balanced				
Easy	No Spacer			

### EXAMPLE SPRING CHARACTERISTIC: DUROLUX EQ 29, 160mm travel

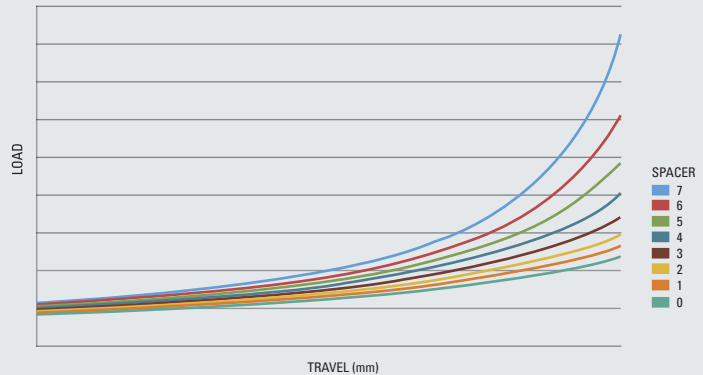

# STANCHION

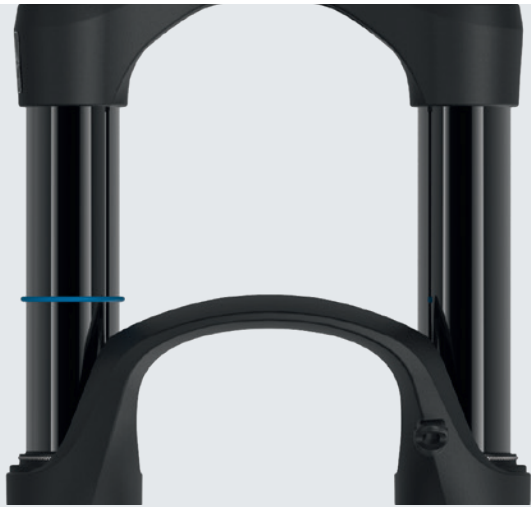

**HARD ANODIZED BLACK** A7 / A6000 series aluminum

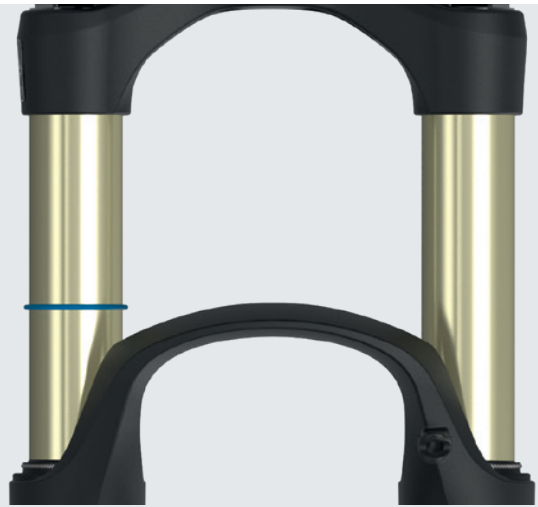

**HARD ANODIZED GOLD** A7 / A6000 series

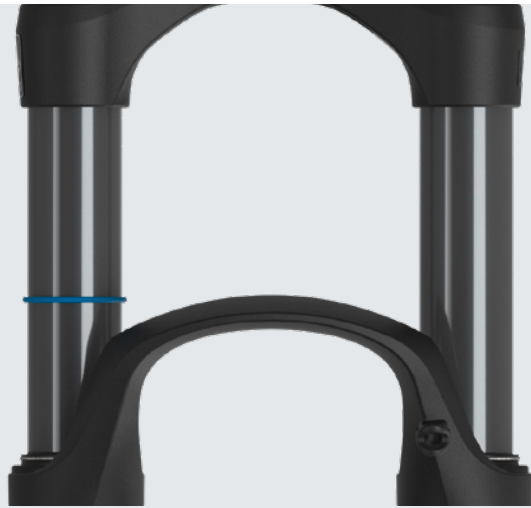

**BLACK STKM**

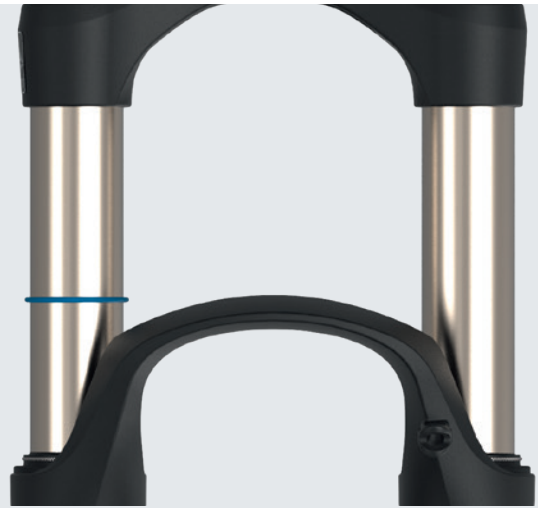

**NI-PLATING STKM**

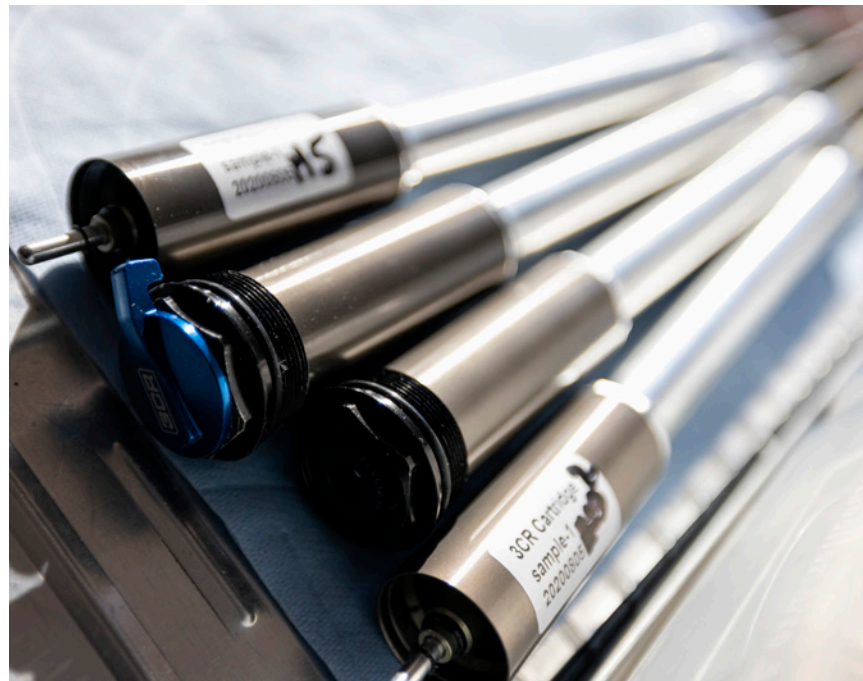
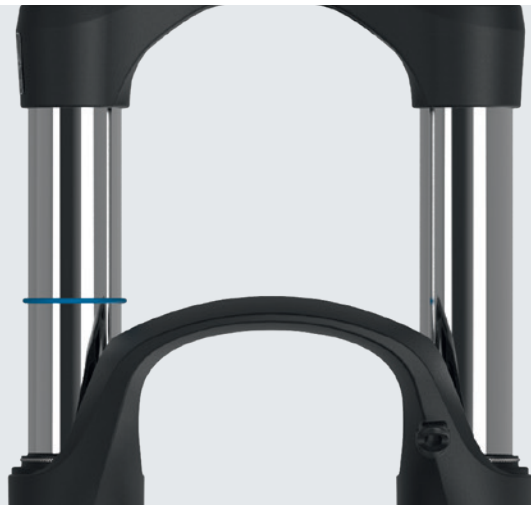

## BOTTOM CASE COLORS



**MATT BLACK**  
Color code YS727



**GLOSS BLACK**  
Color code YS728



**METALLIC SLATE**  
Color code YS941



**GLOSS WHITE**  
Color code YS701

## DECALS



**COMPANY COLOR**  
Black



**COMPANY COLOR**  
White



**METALLIC SLATE**  
Metallic Gray



**STEALTH**  
with glossy decal



**STEALTH**  
with matt decal



# Q-LOC AND THRU AXLE SYSTEMS



Q-LOC is a patented quick release system for thru axles fully deserving of the name "quick". Q-LOC 2 is the logical evolutionary step, guaranteeing 100% compatibility with all kinds of hub axle designs. A simple push and a little twist of the nut enables a quick removal of the axle. Exchanging the axle is as fast as extracting the axle thanks to the patented expander design which smoothly passes the thru axle and latches safely with a reassuring click sound. Safety and speed is crucial when it comes to pressurised wheel changes during a race. Q-LOC2 offers both in a super lightweight axle (Q-LOC2-Ti 70g).



**20QLC2**  
 Ø20mm, O.L.D.: 110mm  
 Weight: 140g



**20LH-110**  
 Ø20mm, O.L.D.: 110mm  
 Weight: 96g



**15QLC2Ti / 15QLC2Ti-110**  
 Ø15mm, O.L.D.: 100mm / 110mm  
 Weight: 68g / 71g



**15QLC2 / 15QLC2-110**  
 Ø15mm, O.L.D.: 100mm / 110mm  
 Weight: 112g/115g



**15QLC32 / 15QLC32-110**  
 Ø15mm, O.L.D.: 100mm/110mm  
 Weight: 118g/122g



**15QLC32S**  
 Ø15mm, O.L.D.: 100mm  
 Weight: 108g



**15AH2 / 15AH2-110 (TOOL TYPE)**  
 Ø15mm, O.L.D.: 100mm / 110mm  
 Weight: 50g / 55g



**15LH / 15LH-110**  
 Ø15mm, O.L.D.: 100mm / 110mm  
 Weight: 88g / 91g



**12AH2 (TOOL TYPE)**  
 Ø12mm, O.L.D.: 100mm



**QR (TOOL FREE)**  
 Ø20mm, O.L.D.: 110mm  
 Weight: 120g



**T (TOOL TYPE)**  
 Ø20mm, O.L.D.: 110mm  
 Weight: 120g

# Q-LOC AND THRU AXLE SYSTEMS

## ASSEMBLY INSTRUCTIONS

**REMOVE QLOC**



**INSERT QLOC**



**WATCH THE VIDEO TUTORIAL!**

APPLICATION TABLE	T	QR	15AH2	15LH / 15LH-110	12AH	15AH2-110	20QLC2	20QLC2-110	20LH-110	15QLC2	15QLC2-110	15QLC32	15QLC32-110	15QLC2Ti	15QLC2Ti-110	15QLC32S
RUX	●	○	-	-	-	-	-	-	-	-	-	-	-	-	-	-
DUROLUX38	-	-	-	○	-	●	-	-	-	-	-	-	-	-	-	-
DUROLUX36	-	-	-	○	-	●	-	-	-	-	-	-	-	-	-	-
AURON	-	-	-	○	-	●	-	-	-	-	-	-	-	-	-	-
AION	-	-	-	○	-	●	-	-	-	-	-	-	-	-	-	-
ZERON	-	-	-	○	-	●	-	-	-	-	-	-	●	-	-	-
AXON34 WERX/ELITE	-	-	-	-	-	-	-	-	-	-	-	-	-	-	●	-
AXON34	-	-	-	○	-	●	-	-	-	-	-	-	-	-	-	-
AXON32	-	-	-	-	-	-	-	-	-	-	●	-	-	-	-	-
RAIDON34	-	-	-	○	-	●	-	-	-	-	-	-	-	-	-	-
RAIDON32	-	-	-	-	-	-	-	-	-	-	-	-	●	-	-	-
XCR	-	-	-	●	-	-	-	-	-	-	-	-	●	-	-	-
XCM	-	-	●	-	-	●	-	-	-	-	-	○	○	-	-	-
X1	-	-	-	-	-	●	-	-	-	-	-	-	-	-	-	-
MOBIE36	-	-	-	○	-	●	-	-	-	-	-	-	-	-	-	-
MOBIE34/25	-	-	●	-	-	●	-	-	-	-	-	●	-	-	-	-
MOBIEA32	-	-	●	-	-	-	-	-	-	-	-	-	-	-	-	-
GVX	-	-	●	-	○	-	-	-	-	-	-	-	-	-	-	-
NRX	-	-	●	-	-	-	-	-	-	-	-	-	-	-	-	●
NX1	-	-	●	-	-	-	-	-	-	-	-	-	-	-	-	-
NVX	-	-	●	-	-	●	-	-	-	-	-	-	-	-	-	-
NCX	-	-	-	-	-	-	-	-	-	-	-	-	-	-	-	●
NEX-E25	-	-	-	-	-	-	-	-	-	-	-	-	-	-	-	●

● standard ○ optional

FEATURE	15QLC2Ti / 15QLC2Ti-110	15QLC2 / 15QLC2-110	15QLC32 / 15QLC32-110	15QLC32S	15LH / 15LH-110	20QLC	20LH-110	15AH2 / 15AH2-110 (TOOL TYPE)
ONE TOUCH RELEASE DESIGN	Yes	Yes	Yes	Yes	No	Yes	No	No
QUICK LEVER	Alloy with CNC machined hole	Alloy with print	Alloy with print	Alloy with print	Alloy with print	Alloy with print	Alloy with print	-
COMPATIBLE O.L.D.	100mm / 110mm	100mm / 110mm	100mm / 110mm	100mm	100mm / 110mm	110mm	110mm	100mm / 110mm
THROUGH AXLE DIAMETER	15mm	15mm	15mm	15mm	15mm	20mm	20mm	15mm
THROUGH AXLE MATERIAL	Alloy (A7075)	Alloy	Cr-mo	Alloy	Alloy	Cr-mo	Alloy	Alloy
QUICK AXLE MATERIAL	Titanium	Cr-mo	Cr-mo	Cr-mo	Cr-mo	Cr-mo	Cr-mo	-
WEIGHT	70g / 72g	112g / 116g	118g / 122g	108g	88g / 91g	140g	96g	NA
PART CODE	FKA069-15	FKA069-05	FKA069-25/26	FKA097-25/26	FKA116-12/ 02	FKA068-05	FKA123-00	FKA117-02/00

## LIGHTWEIGHT HOLLOW CROWN



**HOLLOW CROWN**

### HOLLOW CROWN TECHNOLOGY

Lightweight forged Hollow Crown Technology

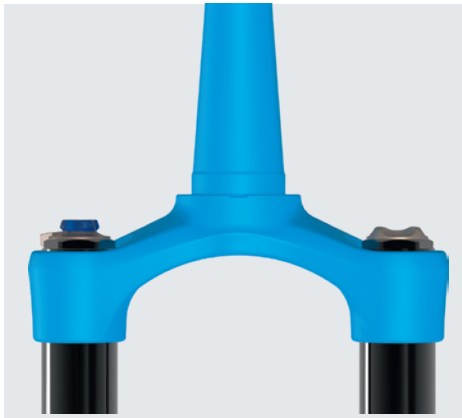

**CARBON**

### CARBON CROWN TECHNOLOGY

Ultra-Lightweight Carbon Crown

## STEERER TUBE



### 1.5"-1 1/8" TAPER

CTS (Conical Tapered Steerer)  
Upper 1-1/8", Lower 1.5"  
Material: Alloy / Carbon / STKM



### 1.8"-1 1/8" TAPER

CTS (Conical Tapered Steerer)  
Upper: 1-1/8", Lower 1.8" Material: Alloy

### 1.8" TAPER

CTS (Conical Tapered Steerer)  
only C74 (74mm crown size)



### 1-1/8"

TS: Upper 1-1/8"  
Material: Alloy / cr-mo / STKM

## STANCHION DIAMETER



## WHEEL SIZE



## BRAKE TYPE



**P**  
PIVOT BRAKE TYPE AKA. V-BRAKE

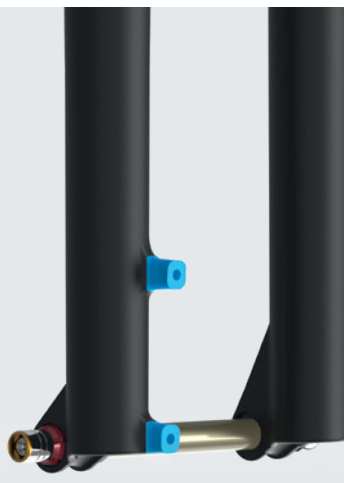

**DS**  
POSTMOUNT DISC BRAKE TYPE



**FDS**  
FLAT MOUNT DISC BRAKE TYPE

## ABS MOUNT



### MODELS WITH ABS SENSOR MOUNT:

DUROLUX38X-EVO-Boost  
AION38X/36X-Boost  
ZERON36X-Boost  
MOBIE36/34-Boost  
MOBIE34-D-Boost  
MOBIE34

### MODELS WITH ABS MOUNT:

DUROLUX38X-EVO-Boost  
AION38X/36X-Boost  
ZERON36X-Boost  
MOBIE36/34-Boost  
MOBIE34-D-Boost  
MOBIE34

For detailed information regarding ABS systems and brake options, please rely on the information provided by the related ABS or brake systems manufacturers.

# HEAD LAMP MOUNT



**INTEGRATED TYPE ON FORK CROWN**  
With smooth cable routing



**INTEGRATED TYPE ON FORK BRACE**



**UNIVERSAL MOUNT**  
Bolt-on

# CABLE GUIDE



**HUB DYNAMO CABLE GUIDE**  
w/screws \*Option

APPLICATION TABLE	ON FORK CROWN	ON FORK BRACE	UNIVERSAL MOUNT	CABLE GUIDE HUB DYNAMO
XCR32-ATB	●	-	-	-
EPIXON32	●	-	-	-
XCM32-ATB	●	-	-	-
XCT	-	-	●	-
XCE	-	-	●	-
M3010	-	-	●	●
MOBIE36/35/34/25/A32	●	-	-	-
NCX	-	●	-	●
NCX32	●	-	-	-
NVX	●	-	-	-
NX1	-	●	-	-
NEX-E25-C	●	-	-	●
NEX-E25	-	●	-	●
NEX	-	●	-	●
TR-HSI	-	-	●	-
CR85-25	-	●	●	●

## SHORT FENDER



**SHORT FENDER MOUNT**  
Detachable integrated short fender

APPLICATION TABLE	SHORT FENDER TYPE
RUX BOOST	●
DUROLUX BOOST	●
AURON BOOST	●
AION BOOST	●
ZERON36/35 BOOST	●
AXON34 WERX/ELITE BOOST	●
AXON34/32 BOOST	●
RAIDON34/32 BOOST	●
RAIDON	-
XCR34/32 BOOST	●
XCR	-
XCR32-ATB	-
X1-BOOST	●
XCM32/30	-
XCM32-ATB	-
XCM34	●
XCT	-
XCE	-
M3010	-
MOBIE36/34 BOOST	●
MOBIE34/25/A32	-
GVX	●
NRX	-
NCX	-
NVX30	-
NX1	-
NCX32	-
NVX	-
NEX	-
CR85-25	-

## LONG FENDER MOUNTS

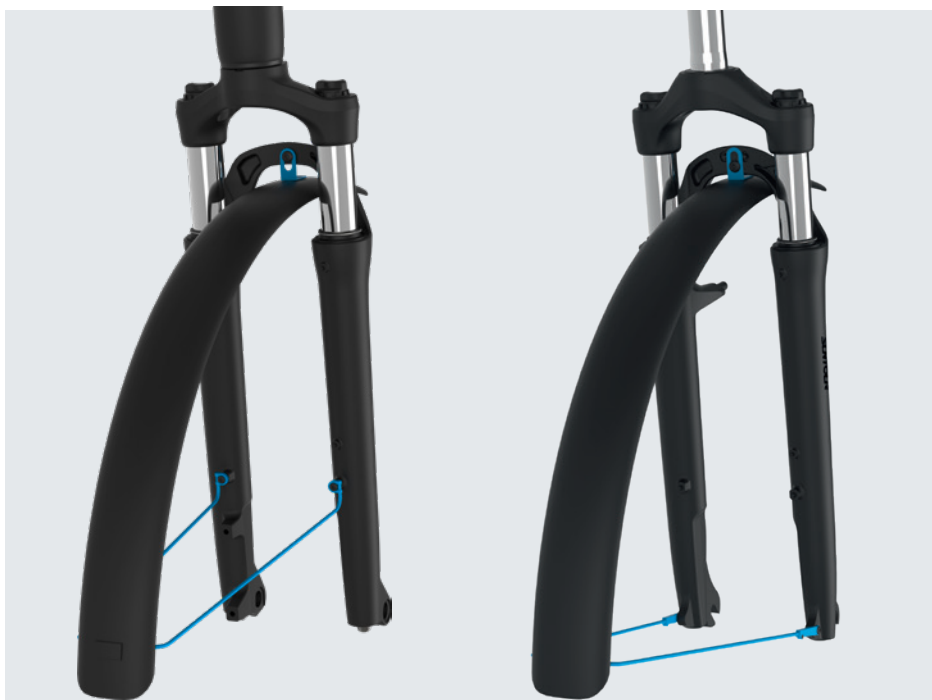

**LONG FENDER TYPE**  
Disc brake type

**LONG FENDER TYPE**  
V-brake

APPLICATION TABLE	LONG FENDER TYPE DISC BRAKE	LONG FENDER TYPE V-BRAKE
RUX BOOST	-	-
DUROLUX BOOST	●	-
AURON BOOST	●	-
AION BOOST	●	-
ZERON36/35 BOOST	●	-
AXON34 WERX/ELITE BOOST	-	-
AXON34/32 BOOST	●	-
RAIDON34/32 BOOST	●	-
RAIDON	●	-
XCR34/32 BOOST	●	-
XCR	●	-
XCR32-ATB	●	-
X1-BOOST	●	-
XCM32/30	●	-
XCM32-ATB	●	-
XCM34	●	-
XCT	-	-
XCE	-	-
M3010	-	●
MOBIE36/34 BOOST	●	-
MOBIE34/25/A32	●	-
GVX	●	-
NRX	●	-
NCX	●	-
NVX30	●	-
NX1	●	-
NCX32	●	-
NVX	●	-
NEX	●	●
CR85-25	●	●



# GLOSSARY REAR SHOCK

## OVERVIEW



### KEY TECHNOLOGIES

- 01 AIR CANISTER
- 02 SHAFT
- 03 PIGGYBACK RESERVOIR
- 04 IFP VALVE CAP (INTERNAL FLOATING PISTON)
- 05 UPPER EYELET (A)
- 06 LOWER EYELET (B)
- 07 REBOUND ADJUSTMENT KNOB
- 08 COMPRESSION ADJUSTMENT
- 09 O-RING
- 10 BUSHING
- 11 AIR VALVE



CHECK OUT THE  
ONLINE REAR  
SHOCK GLOSSARY!



# AIR SPRING MOUNT

TRUNNION MOUNT

STANDARD MOUNT

BUILT-IN LENGTH

BUILT-IN LENGTH

STROKE

STROKE

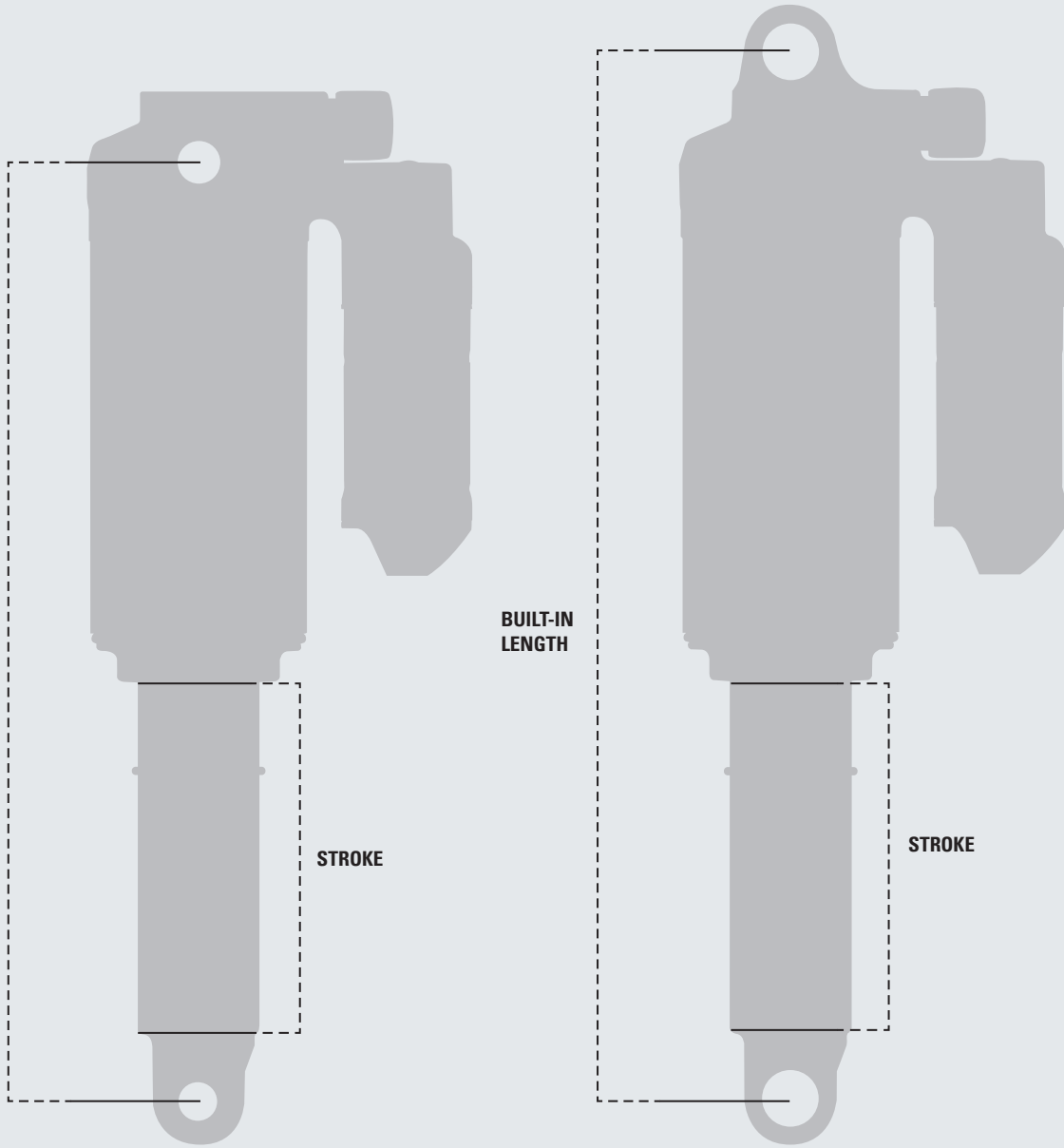

# SPECIFICATIONS



EDGE PLUS INCH		EDGE PLUS METRIC		EDGE PLUS TRUNNION	
EYE TO EYE	STROKE	EYE TO EYE	STROKE	EYE TO EYE	STROKE
152 mm	31 mm	170 mm	27.5/30/32.5/35 mm	145 mm	27.5/30/32.5/35 mm
165 mm	38 mm	190 mm	37.5/40/42.5/45 mm	165 mm	37.5/40/42.5/45 mm
184 mm	44 mm	210 mm	47.5/50/52.5/55 mm	185 mm	47.5/50/52.5/55 mm
190 mm	51 mm	-	-	-	-
200 mm	51/57 mm	-	-	-	-



EDGE INCH		EDGE METRIC		EDGE TRUNNION	
EYE TO EYE	STROKE	EYE TO EYE	STROKE	EYE TO EYE	STROKE
152 mm	31 mm	170 mm	27.5/30/32.5/35 mm	145 mm	27.5/30/32.5/35 mm
165 mm	38 mm	190 mm	37.5/40/42.5/45 mm	165 mm	37.5/40/42.5/45 mm
184 mm	44 mm	-	-	185 mm	47.5/50/52.5/55 mm
190 mm	51 mm	-	-	-	-



EDGE EVO INCH		EDGE EVO METRIC		EDGE EVO TRUNNION	
EYE TO EYE	STROKE	EYE TO EYE	STROKE	EYE TO EYE	STROKE
200 mm	57 mm	190 mm	37.5/40/42.5/45 mm	165 mm	37.5/40/42.5/45 mm
-	-	210 mm	47.5/50/52.5/55 mm	185 mm	47.5/50/52.5/55 mm
-	-	230 mm	57.5/60/62.5/65 mm	205 mm	57.5/60/62.5/65 mm
200 mm	51 mm	-	-	-	-



EDGE X INCH		EDGE X METRIC		EDGE X TRUNNION	
EYE TO EYE	STROKE	EYE TO EYE	STROKE	EYE TO EYE	STROKE
152 mm	31 mm	170 mm	27.5/30/32.5/35 mm	145 mm	27.5/30/32.5/35 mm
165 mm	38 mm	190 mm	37.5/40/42.5/45 mm	165 mm	37.5/40/42.5/45 mm
184 mm	44 mm	210 mm	47.5/50/52.5/55 mm	185 mm	47.5/50/52.5/55 mm
200 mm	51 mm	-	-	-	-



TRIAIR INCH		TRIAIR METRIC		TRIAIR TRUNNION	
EYE TO EYE	STROKE	EYE TO EYE	STROKE	EYE TO EYE	STROKE
200 mm	57 mm	210 mm	47.5/50/52.5/55 mm	185 mm	47.5/50/52.5/55 mm
216 mm	63 mm	230 mm	57.5/60/62.5/65 mm	205 mm	57.5/60/62.5/65 mm
-	-	-	-	225 mm	67.5/70/72.5/75 mm



TRIAIR 2 INCH		TRIAIR 2 METRIC		TRIAIR 2 TRUNNION	
EYE TO EYE	STROKE	EYE TO EYE	STROKE	EYE TO EYE	STROKE
200 mm	51 mm	190 mm	37.5/40/42.5/45 mm	185 mm	47.5/50/52.5/55 mm
		210 mm	47.5/50/52.5/55 mm	205 mm	57.5/60/62.5/65 mm
		230 mm	57.5/60/62.5/65 mm	225 mm	67.5/70/72.5/75 mm
		250 mm	67.5/70/72.5/75 mm	-	-



RAIDON INCH		RAIDON METRIC	
EYE TO EYE	STROKE	EYE TO EYE	STROKE
152 mm	31 mm	170 mm	27.5/30/32.5/35 mm
165 mm	38 mm	190 mm	37.5/40/42.5/45 mm
184 mm	44 mm	-	-
190 mm	51 mm	-	-



# DAMPING ADJUSTMENT



**3CR**  
3 positions of compression (firm setting, medium setting and open setting) with rebound adjust



**2CR**  
2 positions of compression (firm setting and open setting) with rebound adjust



**RC**  
Low speed compression and low speed rebound damping adjust



**R**  
Low speed rebound adjust = 1x adjust sufficient



**R**  
Low speed rebound damping adjust



**R-2CR**  
Remote Lockout (with firm compression setting and open compression setting) with low speed rebound damping adjust



**LO**  
Hydraulic Lockout with low speed compression



**LOR / LOR8**  
LOR: 2-step compression adjust open/lockout with low speed rebound adjust / LOR8: 2CR = 2-step compression adjust with open/ firm with low speed rebound adjust

- Compression damping adjust
- Rebound damping adjust

APPLICATION TABLE	3CR	2CR	RC	R	R-2CR	LO	LOR	LOR8
TRIAIR2	●	●	-	●	-	-	-	-
TRIAIR	●	-	-	●	-	-	-	-
EDGE PLUS	-	●	●	●	-	-	-	-
EDGE	-	-	●	●	-	-	●	●
EDGE EX	-	●	●	●	-	-	-	-
EDGE EVO	-	●	-	●	●	-	-	-
RAIDON	-	-	-	●	-	●	-	-

## SHOCK LENGTH - HOW TO MEASURE TOTAL LENGTH / STROKE LENGTH

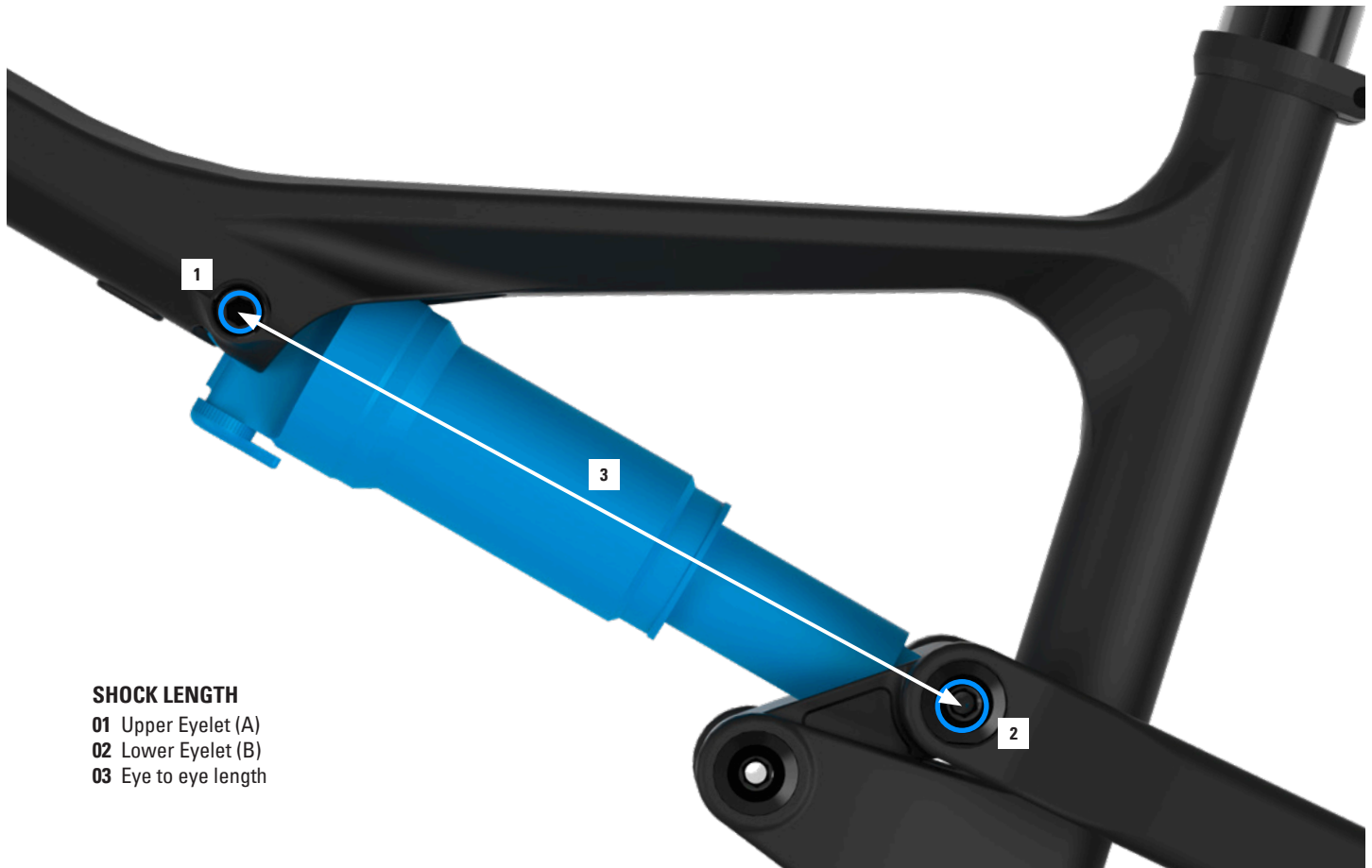

## STROKE LENGTH

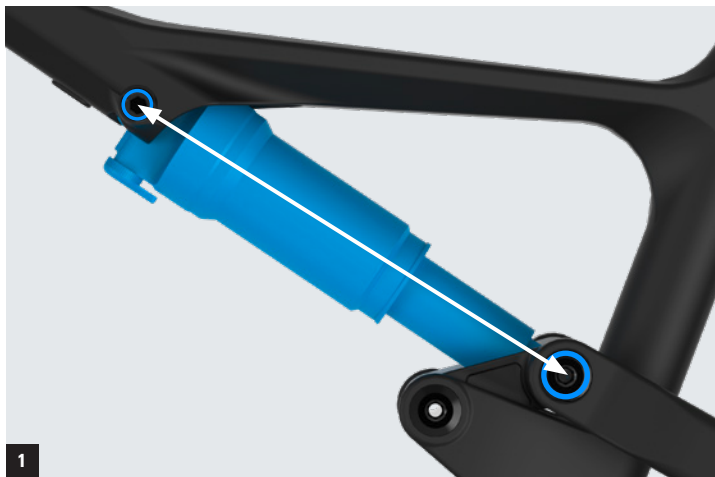

### STROKE LENGTH

- 01 Measure the eye to eye length
- 02 Attach a shock pump and slowly remove all the air from the shock. Compress the shock fully and measure the eye to eye length again.
- 03 Subtract this measurement from the initial eye to eye length to find the usable stroke.



# SAG - HOW TO MEASURE SAG

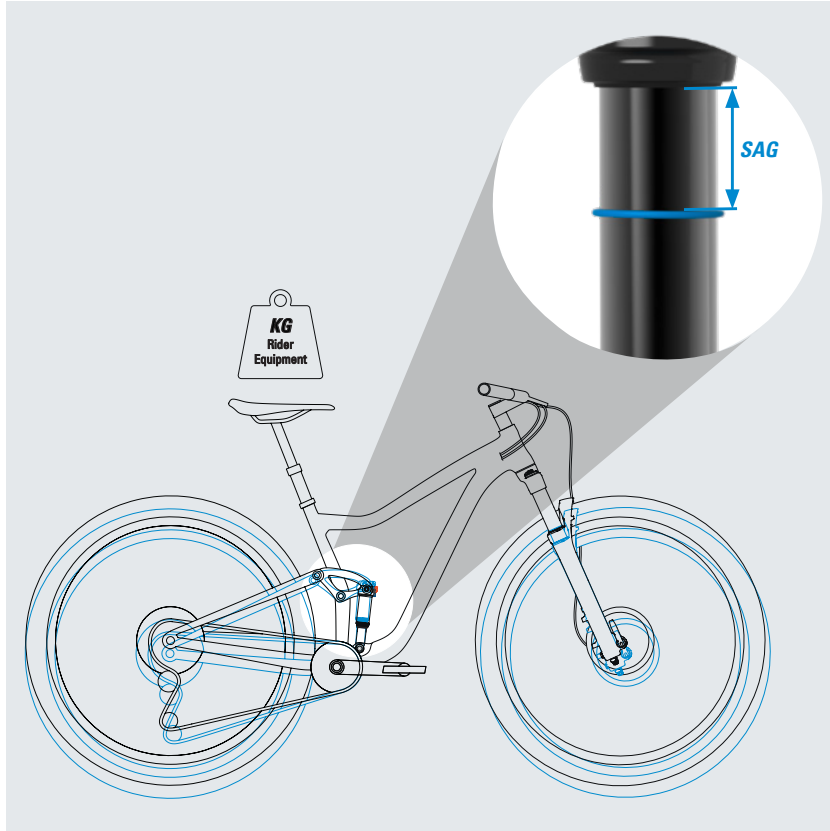

TRAVEL (mm) METRIC/TRUNNION	TRAVEL (mm) IMPERIAL	20% SAG (mm)	25% SAG (mm)	30% SAG (mm)
30	-	6	7,5	9
-	31	6.2	7.75	9.3
35	-	7	8.75	10.5
-	38	7.6	9.5	11.4
40	-	8	10	12
-	44	8.8	11	13.2
45	-	9	11.25	13.5
50	-	10	12.5	15
-	51	10.2	12.75	15.3
55	-	11	13.75	16.5
-	57	11.4	14.25	17.1
60	-	12	15	18
-	63	12.6	15.75	18.9
65	-	13	16.25	19.5
70	-	14	17.5	21
75	-	15	18.75	22.5



# ADJUSTABLE AIR CHAMBER VOLUME



## EXAMPLE SPRING CHARACTERISTIC: EDGE AIR

Shock size 230x65; Pos Air Pressure 100psi; IFP pressure 300 psi

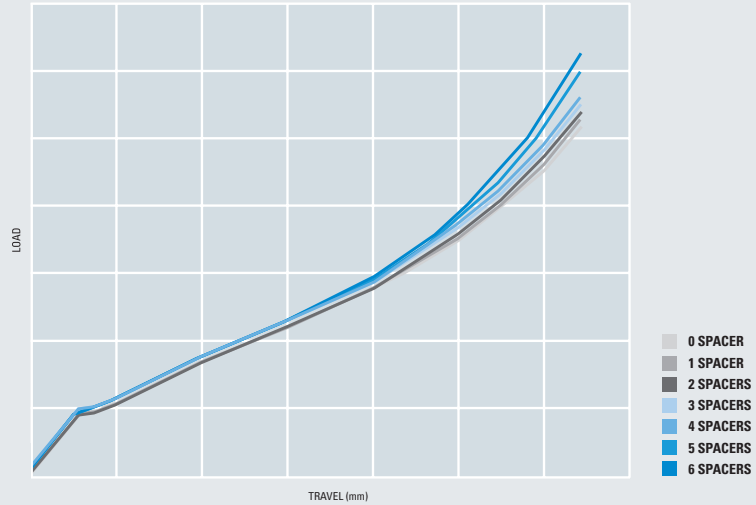

## AIR VOLUME SPACER

### SPACER POSITIV

Manage progression rate  
Bottomless feeling

### SPACER NEGATIV

Manage beginning  
Stroke sensitivity



— Add or remove your desired amount of air volume spacers

— Push downward to remove the high volume air sleeve



## AIR CHAMBERS

01 Positive air chamber

02 Negative air chamber



# BUSHING - PARTS

## 7-PIECE BUSHING

- 01 Eyelet bushings
- 02 Sealing rings
- 03 Igu bushings
- 04 Axle / pin

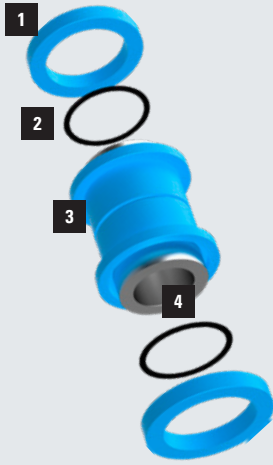

## 3-PIECE BUSHING

- 01 Eyelet bushings
- 02 DU bushing

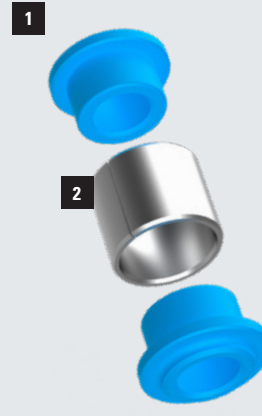

# BUSHING - HOW TO MEASURE HARDWARE SIZE



1 Width



2 Bolt diameter



# AIR VOLUME OPTIONS



**TRIAIR / OPTION 1**  
SV: Small positive air volume and small negative air volume.



**TRIAIR / OPTION 2**  
LVN: Small positive air volume and large negative air volume.



**TRIAIR2 / OPTION 1**  
SV: Small positive air volume and small negative air volume.



**TRIAIR2 / OPTION 2**  
LVN: Small positive air volume and large negative air volume.



**EDGE EVO / OPTION 1**  
LVN: Small positive air volume and large negative air volume.



**EDGE EVO / OPTION 2**  
LV: Large positive air volume and large negative air volume.



**EDGE X / OPTION 1**  
LV: Large positive air volume and large negative air volume.



**EDGE X / OPTION 2**  
SV: Small positive air volume and small negative air volume.



RIDER: JUAN DUARTE LOCATION: FREIBURG GERMANY PHOTO: JORDI MOLFULLEDA

# RUX38

DOWNHILL / FREERIDE



38 Boost R2C2-PCS 29"



38 Boost R2C2-PCS 27.5"



DOWNHILL / FREERIDE

RUX38

MODEL YEAR	MODEL NAME	MAIN SPECIFICATIONS										CROWN			STANCHION			STEERER TUBE		AXLE			BOTTOM CASE / BRAKE		
		E-Bike ready	Weight (g) w/o axle	Wheel / Max. suggested tire size	Max allowed Tire Width (mm)	Max allowed Tire O.D. (mm)	Travel (mm)	Damper	Spring	Mat.	Method	DIA (mm)	Mat.	Finish	Pitch (mm)	Size	Material	O.L.D.	Axle	Mat.	Max rotor DIA	Brake mount			
SF21	RUX38-BOOST-EQ R2C2-PCS DS T 29"	no	-	29"x2.8"	73	770	200	R2C2-PCS	AIR (EQ)	Al	Upper: Solid Lower: Hollow	38	Al	Hard anodized, Black	-	1-1/8" (TS), Alloy, (OP) 1.5" to 1-1/8" tapered (CTS), Alloy	ø20-110	20mm Tool type	Mg	220mm	Post 203 Direct				
SF21	RUX38-BOOST-EQ RC2-PCS DS T 29"	no	-	29"x2.8"	73	770	200	RC2-PCS	AIR (EQ)	Al	Upper: Solid Lower: Hollow	38	Al	Hard anodized, Black	-	1-1/8" (TS), Alloy, (OP) 1.5" to 1-1/8" tapered (CTS), Alloy	ø20-110	20mm Tool type	Mg	220mm	Post 203 Direct				
SF23	RUX38-BOOST-EQ R2C2-PCS DS T 27.5"	no	2870	27.5"x2.8"	73	732	200	R2C2-PCS	AIR	Al	Upper: Solid Lower: Hollow	38	Al	Hard anodized, Black	-	1-1/8" (TS), Alloy, (OP) 1.5" to 1-1/8" tapered (CTS), Alloy	ø20-110	20mm Tool type	Mg	220mm	Post 203 Direct				
SF23	RUX38-BOOST-EQ RC2-PCS DS T 27.5"	no	2845	27.5"x2.8"	73	732	200	RC2-PCS	AIR	Al	Upper: Solid Lower: Hollow	38	Al	Hard anodized, Black	-	1-1/8" (TS), Alloy, (OP) 1.5" to 1-1/8" tapered (CTS), Alloy	ø20-110	20mm Tool type	Mg	220mm	Post 203 Direct				

SPECIFICATIONS

// 2/25



# DUROLUX38

ENDURO

29"

38mm

38X EVO Boost EQ  
ABS RC+-PCS 29"



ENDURO

DUROLUX38

SPECIFICATIONS

// 2125



MODEL YEAR	MODEL NAME	MAIN SPECIFICATIONS										CROWN		STANCHION		STEERER TUBE		AXLE		BOTTOM CASE / BRAKE	
		E-Bike ready	Weight (g) w/o axle	Wheel / Max suggested tire size	Max allowed Tire Width	Max allowed Tire O.D.	Travel (mm)	Damper	Spring	Offset (mm)	Mat.	DIA (mm)	Mat.	Finish	Size Material	O.L.D.	Axle	Mat.	Max rotor DIA	Brake mount	
SF25	DUROLUX38X-EVO-Boost EQ ABS RC+-PCS DS 15AH2-110 29"	yes	-	29"x2.6"	67mm	762mm	160 170 180	RC+-PCS	AIR (EQ)	44	Al	38	Al	Hard anodized, Black	1.5"to1-1/8" tapered(CTS), Alloy, (OP) 1.8"to1-1/8" tapered(CTS), Alloy	ø15-110	15AH2-110, (OP) 15LH-110	Mg	220mm	Post 203 Direct	
SF25	DUROLUX38X-EVO-Boost EQ RC+-PCS DS 15AH2-110 29"	yes	-	29"x2.6"	67mm	762mm	160 170 180	RC+-PCS	AIR (EQ)	44	Al	38	Al	Hard anodized, Black	1.5"to1-1/8" tapered(CTS), Alloy, (OP) 1.8"to1-1/8" tapered(CTS), Alloy	ø15-110	15AH2-110, (OP) 15LH-110	Mg	220mm	Post 203 Direct	
SF25	DUROLUX38-EVO-Boost EQ RC+-PCS DS 15AH2-110 29"	no	-	29"x2.6"	67mm	762mm	160 170 180	RC+-PCS	AIR (EQ)	44	Al	38	Al	Hard anodized, Black	1.5"to1-1/8" tapered(CTS), Alloy, (OP) 1.8"to1-1/8" tapered(CTS), Alloy	ø15-110	15AH2-110, (OP) 15LH-110	Mg	220mm	Post 203 Direct	

# DUROLUX36 X

ENDURO

29"

27.5"

36mm

36X EVO Boost EQ  
ABS RC+-PCS 29"



METALLIC-SLATE

GLOSS BLACK

MATT BLACK

GLOSS WHITE

ENDURO

DUROLUX36 X

SPECIFICATIONS

// 21/25



		MAIN SPECIFICATIONS										CROWN			STANCHION			STEERER TUBE		AXLE		BOTTOM CASE / BRAKE		
MODEL YEAR	MODEL NAME	E-Bike ready	Weight (g) w/o axle	Wheel / Max. suggested tire size	Max allowed Tire Width	Max allowed Tire O.D.	Travel (mm)	Damper	Spring	Offset (mm)	Mat.	DIA (mm)	Mat.	Finish	Size Material	O.L.D.	Axle	Mat.	Max rotor DIA	Brake mount				
SF25	DUROLUX36X-EVO-Boost EQ RC+-PCS DS 15AH2-110 29"	yes	-	29"x2.6"	67mm	756mm	150 160	RC+-PCS	AIR (EQ)	44	Al	36	Al	Hard anodized, Black	1.5"to1-1/8" tapered(CTS), Alloy (OP) 1.8"to1-1/8" tapered(CTS), Alloy	ø15-110	15AH2-110, (OP) 15LH-110	Mg	220mm	Post 180 Direct				
SF25	DUROLUX36X-EVO-Boost EQ RC+-PCS DS 15AH2-110 27.5"	yes	-	27.5"x2.6"	67mm	723mm	150 160	RC+-PCS	AIR (EQ)	44	Al	36	Al	Hard anodized, Black	1.5"to1-1/8" tapered(CTS), Alloy (OP) 1.8"to1-1/8" tapered(CTS), Alloy	ø15-110	15AH2-110, (OP) 15LH-110	Mg	220mm	Post 180 Direct				

# AURON36

ENDURO / ALL MOUNTAIN

29"

27.5"

36mm

EVO Boost EQ ABS  
RC+-PCS 29"



ENDURO / AM

AURON36

SPECIFICATIONS

// 2025



		MAIN SPECIFICATIONS										CROWN		STANCHION		STEERER TUBE	AXLE		BOTTOM CASE / BRAKE		
MODEL YEAR	MODEL NAME	E-Bike ready	Weight (g) w/o axle	Wheel / Max. suggested tire size	Max allowed Tire Width	Max allowed Tire O.D.	Travel (mm)	Damper	Spring	Offset (mm)	Mat.	DIA (mm)	Mat.	Finish	Size Material	O.L.D.	Axle	Mat.	Max rotor DIA	Brake mount	
SF25	AURON36-EVO-Boost EQ RC+-PCS DS 15AH2-110 29"	no	-	29"x2.6"	67mm	756mm	140 150 160	RC+-PCS	AIR (EQ)	44	Al	36	Al	Hard anodized, Black	1.5"to1-1/8" tapered(CTS), Alloy, (OP) 1.8"to1-1/8" tapered(CTS), Alloy	ø15-110	15AH2-110, (OP) 15LH-110	Mg	220mm	Post 180 Direct	
SF25	AURON36-EVO-Boost EQ RC+-PCS DS 15AH2-110 27.5"	no	-	27.5"x2.6"	67mm	723mm	140 150 160	RC+-PCS	AIR (EQ)	44	Al	36	Al	Hard anodized, Black	1.5"to1-1/8" tapered(CTS), Alloy, (OP) 1.8"to1-1/8" tapered(CTS), Alloy	ø15-110	15AH2-110, (OP) 15LH-110	Mg	220mm	Post 180 Direct	

Boost EQ ABS  
3CR-PCS 29"



TRAIL / AM

AION36

		MAIN SPECIFICATIONS											CROWN		STANCHION		STEERER TUBE		AXLE		BOTTOM CASE / BRAKE		
MODEL YEAR	MODEL NAME	E-Bike ready	Weight (g) w/o axle	Wheel / Max. suggested tire size	Max allowed Tire Width	Max allowed Tire O.D.	Travel (mm)	Damper	Spring	Offset (mm)	Mat.	DIA (mm)	Mat.	Finish	Size Material	O.L.D.	Axle	Mat.	Max rotor DIA	Brake mount			
SF25	AION36-Boost EQ 3CR-PCS DS 15AH2-110 29"	no	-	29"x2.6"	67mm	756mm	120/130/140/150/160	3CR-PCS	AIR (EQ)	44	Al	36	Al	Hard anodized, Black	1.5"to1-1/8" tapered(CTS), Alloy, (OP) 1.8"to1-1/8" tapered(CTS), Alloy	ø15-110	15AH2-110, (OP) 15LH-110	Mg	220mm	Post 180 Direct			
SF25	AION36-Boost EQ LORC-PCS DS 15AH2-110 29"	no	-	29"x2.6"	67mm	756mm	120/130/140/150/160	LORC-PCS	AIR (EQ)	44	Al	36	Al	Hard anodized, Black	1.5"to1-1/8" tapered(CTS), Alloy, (OP) 1.8"to1-1/8" tapered(CTS), Alloy	ø15-110	15AH2-110, (OP) 15LH-110	Mg	220mm	Post 180 Direct			
SF25	AION36-Boost EQ 2CR-PCS DS 15AH2-110 29"	no	-	29"x2.6"	67mm	756mm	120/130/140/150/160	2CR-PCS	AIR (EQ)	44	Al	36	Al	Hard anodized, Black	1.5"to1-1/8" tapered(CTS), Alloy, (OP) 1.8"to1-1/8" tapered(CTS), Alloy	ø15-110	15AH2-110, (OP) 15LH-110	Mg	220mm	Post 180 Direct			
SF25	AION36-Boost EQ RC-PCS DS 15AH2-110 29"	no	-	29"x2.6"	67mm	756mm	120/130/140/150/160	RC-PCS	AIR (EQ)	44	Al	36	Al	Hard anodized, Black	1.5"to1-1/8" tapered(CTS), Alloy, (OP) 1.8"to1-1/8" tapered(CTS), Alloy	ø15-110	15AH2-110, (OP) 15LH-110	Mg	220mm	Post 180 Direct			
SF25	AION36-Boost EQ 3CR-PCS DS 15AH2-110 27.5"	no	-	27.5"x2.6"	67mm	723mm	120/130/140/150/160	3CR-PCS	AIR (EQ)	44	Al	36	Al	Hard anodized, Black	1.5"to1-1/8" tapered(CTS), Alloy, (OP) 1.8"to1-1/8" tapered(CTS), Alloy	ø15-110	15AH2-110, (OP) 15LH-110	Mg	220mm	Post 180 Direct			
SF25	AION36-Boost EQ LORC-PCS DS 15AH2-110 27.5"	no	-	27.5"x2.6"	67mm	723mm	120/130/140/150/160	LORC-PCS	AIR (EQ)	44	Al	36	Al	Hard anodized, Black	1.5"to1-1/8" tapered(CTS), Alloy, (OP) 1.8"to1-1/8" tapered(CTS), Alloy	ø15-110	15AH2-110, (OP) 15LH-110	Mg	220mm	Post 180 Direct			
SF25	AION36-Boost EQ 2CR-PCS DS 15AH2-110 27.5"	no	-	27.5"x2.6"	67mm	723mm	120/130/140/150/160	2CR-PCS	AIR (EQ)	44	Al	36	Al	Hard anodized, Black	1.5"to1-1/8" tapered(CTS), Alloy, (OP) 1.8"to1-1/8" tapered(CTS), Alloy	ø15-110	15AH2-110, (OP) 15LH-110	Mg	220mm	Post 180 Direct			
SF25	AION36-Boost EQ RC-PCS DS 15AH2-110 27.5"	no	-	27.5"x2.6"	67mm	723mm	120/130/140/150/160	RC-PCS	AIR (EQ)	44	Al	36	Al	Hard anodized, Black	1.5"to1-1/8" tapered(CTS), Alloy, (OP) 1.8"to1-1/8" tapered(CTS), Alloy	ø15-110	15AH2-110, (OP) 15LH-110	Mg	220mm	Post 180 Direct			

SPECIFICATIONS

// 21025

SFSAIOTOR

# AION36X

TRAIL / ALL MOUNTAIN

29"

27.5"

36mm

36X Boost EQ ABS  
3CR-PCS 29"



TRAIL / AM

AION36X

MODEL YEAR	MODEL NAME	MAIN SPECIFICATIONS											CROWN		STANCHION		STEERER TUBE		AXLE		BOTTOM CASE / BRAKE		
		E-Bike ready	Weight (g) w/o axle	Wheel / Max. suggested tire size	Max allowed Tire Width	Max allowed Tire O.D.	Travel (mm)	Damper	Spring	Offset (mm)	Mat.	DIA (mm)	Mat.	Finish	Size Material	O.L.D.	Axle	Mat.	Max rotor DIA	Brake mount			
SF25	AION36X-Boost EQ ABS 3CR-PCS DS 15AH2-110 29"	yes	-	29"x2.6"	67mm	756mm	120/130 140/150 160	3CR-PCS	AIR (EQ)	44	Al	36	Al	Hard anodized, Black	1.5"to 1-1/8" tapered(CTS), Alloy, (OP) 1.8"to 1-1/8" tapered(CTS), Alloy	ø15-110	15AH2-110, (OP) 15LH-110	Mg	220mm	Post 180 Direct			
SF25	AION36X-Boost EQ 3CR-PCS DS 15AH2-110 29"	yes	-	29"x2.6"	67mm	756mm	120/130 140/150 160	3CR-PCS	AIR (EQ)	44	Al	36	Al	Hard anodized, Black	1.5"to 1-1/8" tapered(CTS), Alloy, (OP) 1.8"to 1-1/8" tapered(CTS), Alloy	ø15-110	15AH2-110, (OP) 15LH-110	Mg	220mm	Post 180 Direct			
SF25	AION36X-Boost EQ ABS LORC-PCS DS 15AH2-110 29"	yes	-	29"x2.6"	67mm	756mm	120/130 140/150 160	LORC-PCS	AIR (EQ)	44	Al	36	Al	Hard anodized, Black	1.5"to 1-1/8" tapered(CTS), Alloy, (OP) 1.8"to 1-1/8" tapered(CTS), Alloy	ø15-110	15AH2-110, (OP) 15LH-110	Mg	220mm	Post 180 Direct			
SF25	AION36X-Boost EQ LORC-PCS DS 15AH2-110 29"	yes	-	29"x2.6"	67mm	756mm	120/130 140/150 160	LORC-PCS	AIR (EQ)	44	Al	36	Al	Hard anodized, Black	1.5"to 1-1/8" tapered(CTS), Alloy, (OP) 1.8"to 1-1/8" tapered(CTS), Alloy	ø15-110	15AH2-110, (OP) 15LH-110	Mg	220mm	Post 180 Direct			
SF25	AION36X-Boost EQ ABS 2CR-PCS DS 15AH2-110 29"	yes	-	29"x2.6"	67mm	756mm	120/130 140/150 160	2CR-PCS	AIR (EQ)	44	Al	36	Al	Hard anodized, Black	1.5"to 1-1/8" tapered(CTS), Alloy, (OP) 1.8"to 1-1/8" tapered(CTS), Alloy	ø15-110	15AH2-110, (OP) 15LH-110	Mg	220mm	Post 180 Direct			
SF25	AION36X-Boost EQ 2CR-PCS DS 15AH2-110 29"	yes	-	29"x2.6"	67mm	756mm	120/130 140/150 160	2CR-PCS	AIR (EQ)	44	Al	36	Al	Hard anodized, Black	1.5"to 1-1/8" tapered(CTS), Alloy, (OP) 1.8"to 1-1/8" tapered(CTS), Alloy	ø15-110	15AH2-110, (OP) 15LH-110	Mg	220mm	Post 180 Direct			
SF25	AION36X-Boost EQ ABS RC-PCS DS 15AH2-110 29"	yes	-	29"x2.6"	67mm	756mm	120/130 140/150 160	RC-PCS	AIR (EQ)	44	Al	36	Al	Hard anodized, Black	1.5"to 1-1/8" tapered(CTS), Alloy, (OP) 1.8"to 1-1/8" tapered(CTS), Alloy	ø15-110	15AH2-110, (OP) 15LH-110	Mg	220mm	Post 180 Direct			
SF25	AION36X-Boost EQ RC-PCS DS 15AH2-110 29"	yes	-	29"x2.6"	67mm	756mm	120/130 140/150 160	RC-PCS	AIR (EQ)	44	Al	36	Al	Hard anodized, Black	1.5"to 1-1/8" tapered(CTS), Alloy, (OP) 1.8"to 1-1/8" tapered(CTS), Alloy	ø15-110	15AH2-110, (OP) 15LH-110	Mg	220mm	Post 180 Direct			

SPECIFICATIONS

// 21025

SF SUTOUR



# AION36X

TRAIL / ALL MOUNTAIN

29"

27.5"

36mm

36X Boost EQ ABS  
3CR-PCS 29"



		MAIN SPECIFICATIONS											CROWN		STANCHION		STEERER TUBE		AXLE		BOTTOM CASE / BRAKE		
MODEL YEAR	MODEL NAME	E-Bike ready	Weight (g) w/o axle	Wheel / Max. suggested tire size	Max allowed Tire Width	Max allowed Tire O.D.	Travel (mm)	Damper	Spring	Offset (mm)	Mat.	DIA (mm)	Mat.	Finish	Size Material	O.L.D.	Axle	Mat.	Max rotor DIA	Brake mount			
SF25	AION36X-Boost EQ ABS 3CR-PCS DS 15AH2-110 27.5"	yes	-	27.5"x2.6"	67mm	723mm	120/130 140/150 160	3CR-PCS	AIR (EQ)	44	Al	36	Al	Hard anodized, Black	1.5"to1-1/8" tapered(CTS), Alloy, (OP) 1.8"to1-1/8" tapered(CTS), Alloy	ø15-110	15AH2-110, (OP) 15LH-110	Mg	220mm	Post 180 Direct			
SF25	AION36X-Boost EQ 3CR-PCS DS 15AH2-110 27.5"	yes	-	27.5"x2.6"	67mm	723mm	120/130 140/150 160	3CR-PCS	AIR (EQ)	44	Al	36	Al	Hard anodized, Black	1.5"to1-1/8" tapered(CTS), Alloy, (OP) 1.8"to1-1/8" tapered(CTS), Alloy	ø15-110	15AH2-110, (OP) 15LH-110	Mg	220mm	Post 180 Direct			
SF25	AION36X-Boost EQ ABS LORC-PCS DS 15AH2-110 27.5"	yes	-	27.5"x2.6"	67mm	723mm	120/130 140/150 160	LORC-PCS	AIR (EQ)	44	Al	36	Al	Hard anodized, Black	1.5"to1-1/8" tapered(CTS), Alloy, (OP) 1.8"to1-1/8" tapered(CTS), Alloy	ø15-110	15AH2-110, (OP) 15LH-110	Mg	220mm	Post 180 Direct			
SF25	AION36X-Boost EQ LORC-PCS DS 15AH2-110 27.5"	yes	-	27.5"x2.6"	67mm	723mm	120/130 140/150 160	LORC-PCS	AIR (EQ)	44	Al	36	Al	Hard anodized, Black	1.5"to1-1/8" tapered(CTS), Alloy, (OP) 1.8"to1-1/8" tapered(CTS), Alloy	ø15-110	15AH2-110, (OP) 15LH-110	Mg	220mm	Post 180 Direct			
SF25	AION36X-Boost EQ ABS 2CR-PCS DS 15AH2-110 27.5"	yes	-	27.5"x2.6"	67mm	723mm	120/130 140/150 160	2CR-PCS	AIR (EQ)	44	Al	36	Al	Hard anodized, Black	1.5"to1-1/8" tapered(CTS), Alloy, (OP) 1.8"to1-1/8" tapered(CTS), Alloy	ø15-110	15AH2-110, (OP) 15LH-110	Mg	220mm	Post 180 Direct			
SF25	AION36X-Boost EQ 2CR-PCS DS 15AH2-110 27.5"	yes	-	27.5"x2.6"	67mm	723mm	120/130 140/150 160	2CR-PCS	AIR (EQ)	44	Al	36	Al	Hard anodized, Black	1.5"to1-1/8" tapered(CTS), Alloy, (OP) 1.8"to1-1/8" tapered(CTS), Alloy	ø15-110	15AH2-110, (OP) 15LH-110	Mg	220mm	Post 180 Direct			
SF25	AION36X-Boost EQ ABS RC-PCS DS 15AH2-110 27.5"	yes	-	27.5"x2.6"	67mm	723mm	120/130 140/150 160	RC-PCS	AIR (EQ)	44	Al	36	Al	Hard anodized, Black	1.5"to1-1/8" tapered(CTS), Alloy, (OP) 1.8"to1-1/8" tapered(CTS), Alloy	ø15-110	15AH2-110, (OP) 15LH-110	Mg	220mm	Post 180 Direct			
SF25	AION36X-Boost EQ RC-PCS DS 15AH2-110 27.5"	yes	-	27.5"x2.6"	67mm	723mm	120/130 140/150 160	RC-PCS	AIR (EQ)	44	Al	36	Al	Hard anodized, Black	1.5"to1-1/8" tapered(CTS), Alloy, (OP) 1.8"to1-1/8" tapered(CTS), Alloy	ø15-110	15AH2-110, (OP) 15LH-110	Mg	220mm	Post 180 Direct			

TRAIL / AM

AION36X

SPECIFICATIONS

// 21/25

SFSAIOTOR

# AION38X

TRAIL / ALL MOUNTAIN

29"

27.5"

38mm

38X Boost EQ ABS  
3CR-PCS 29"



MODEL YEAR	MODEL NAME	MAIN SPECIFICATIONS										CROWN		STANCHION		STEERER TUBE		AXLE		BOTTOM CASE / BRAKE		
		E-Bike ready	Weight (g) w/o axle	Wheel / Max. suggested tire size	Max allowed Tire Width	Max allowed Tire O.D.	Travel (mm)	Damper	Spring	Offset (mm)	Mat.	DIA (mm)	Mat.	Finish	Size	Material	O.L.D.	Axle	Mat.	Max rotor DIA	Brake mount	
SF25	AION38X-Boost EQ ABS 3CR-PCS DS 15AH2-110 29"	yes	-	29"x2.6"	67mm	756mm	160 170 180	3CR-PCS	AIR (EQ)	44	Al	38	Al	Hard anodized, Black	1.5"to 1-1/8" tapered(CTS), Alloy, (OP) 1.8"to 1-1/8" tapered(CTS), Alloy	ø15-110	15AH2-110, (OP) 15LH-110	Mg	220mm	Post 203 Direct		
SF25	AION38X-Boost EQ 3CR-PCS DS 15AH2-110 29"	yes	-	29"x2.6"	67mm	756mm	160 170 180	3CR-PCS	AIR (EQ)	44	Al	38	Al	Hard anodized, Black	1.5"to 1-1/8" tapered(CTS), Alloy, (OP) 1.8"to 1-1/8" tapered(CTS), Alloy	ø15-110	15AH2-110, (OP) 15LH-110	Mg	220mm	Post 203 Direct		
SF25	AION38X-Boost EQ ABS LORC-PCS DS 15AH2-110 29"	yes	-	29"x2.6"	67mm	756mm	160 170 180	LORC-PCS	AIR (EQ)	44	Al	38	Al	Hard anodized, Black	1.5"to 1-1/8" tapered(CTS), Alloy, (OP) 1.8"to 1-1/8" tapered(CTS), Alloy	ø15-110	15AH2-110, (OP) 15LH-110	Mg	220mm	Post 203 Direct		
SF25	AION38X-Boost EQ LORC-PCS DS 15AH2-110 29"	yes	-	29"x2.6"	67mm	756mm	160 170 180	LORC-PCS	AIR (EQ)	44	Al	38	Al	Hard anodized, Black	1.5"to 1-1/8" tapered(CTS), Alloy, (OP) 1.8"to 1-1/8" tapered(CTS), Alloy	ø15-110	15AH2-110, (OP) 15LH-110	Mg	220mm	Post 203 Direct		
SF25	AION38X-Boost EQ ABS 2CR-PCS DS 15AH2-110 29"	yes	-	29"x2.6"	67mm	756mm	160 170 180	2CR-PCS	AIR (EQ)	44	Al	38	Al	Hard anodized, Black	1.5"to 1-1/8" tapered(CTS), Alloy, (OP) 1.8"to 1-1/8" tapered(CTS), Alloy	ø15-110	15AH2-110, (OP) 15LH-110	Mg	220mm	Post 203 Direct		
SF25	AION38X-Boost EQ 2CR-PCS DS 15AH2-110 29"	yes	-	29"x2.6"	67mm	756mm	160 170 180	2CR-PCS	AIR (EQ)	44	Al	38	Al	Hard anodized, Black	1.5"to 1-1/8" tapered(CTS), Alloy, (OP) 1.8"to 1-1/8" tapered(CTS), Alloy	ø15-110	15AH2-110, (OP) 15LH-110	Mg	220mm	Post 203 Direct		
SF25	AION38X-Boost EQ ABS RC-PCS DS 15AH2-110 29"	yes	-	29"x2.6"	67mm	756mm	160 170 180	RC-PCS	AIR (EQ)	44	Al	38	Al	Hard anodized, Black	1.5"to 1-1/8" tapered(CTS), Alloy, (OP) 1.8"to 1-1/8" tapered(CTS), Alloy	ø15-110	15AH2-110, (OP) 15LH-110	Mg	220mm	Post 203 Direct		
SF25	AION38X-Boost EQ RC-PCS DS 15AH2-110 29"	yes	-	29"x2.6"	67mm	756mm	160 170 180	RC-PCS	AIR (EQ)	44	Al	38	Al	Hard anodized, Black	1.5"to 1-1/8" tapered(CTS), Alloy, (OP) 1.8"to 1-1/8" tapered(CTS), Alloy	ø15-110	15AH2-110, (OP) 15LH-110	Mg	220mm	Post 203 Direct		

TRAIL / AM

AION38X

SPECIFICATIONS

// 2125

SUNTOUR

# AION38X

TRAIL / ALL MOUNTAIN

29"

27.5"

38mm

38X Boost EQ ABS  
3CR-PCS 29"



MODEL YEAR	MODEL NAME	MAIN SPECIFICATIONS										CROWN		STANCHION		STEERER TUBE		AXLE		BOTTOM CASE / BRAKE		
		E-Bike ready	Weight (g) w/o axle	Wheel / Max. suggested tire size	Max allowed Tire Width	Max allowed Tire O.D.	Travel (mm)	Damper	Spring	Offset (mm)	Mat.	DIA (mm)	Mat.	Finish	Size Material	O.L.D.	Axle	Mat.	Max rotor DIA	Brake mount		
SF25	AION38X-Boost EQ ABS 3CR-PCS DS 15AH2-110 27.5"	yes	-	27.5"2.6"	67mm	723mm	160 170	3CR-PCS	AIR (EQ)	44	Al	38	Al	Hard anodized, Black	1.5"to1-1/8" tapered(CTS), Alloy, (OP) 1.8"to1-1/8" tapered(CTS), Alloy	ø15-110	15AH2-110, (OP) 15LH-110	Mg	220 mm	Post 203 Direct		
SF25	AION38X-Boost EQ 3CR-PCS DS 15AH2-110 27.5"	yes	-	27.5"2.6"	67mm	723mm	160 170	3CR-PCS	AIR (EQ)	44	Al	38	Al	Hard anodized, Black	1.5"to1-1/8" tapered(CTS), Alloy, (OP) 1.8"to1-1/8" tapered(CTS), Alloy	ø15-110	15AH2-110, (OP) 15LH-110	Mg	220 mm	Post 203 Direct		
SF25	AION38X-Boost EQ ABS LORC-PCS DS 15AH2-110 27.5"	yes	-	27.5"2.6"	67mm	723mm	160 170	LORC-PCS	AIR (EQ)	44	Al	38	Al	Hard anodized, Black	1.5"to1-1/8" tapered(CTS), Alloy, (OP) 1.8"to1-1/8" tapered(CTS), Alloy	ø15-110	15AH2-110, (OP) 15LH-110	Mg	220 mm	Post 203 Direct		
SF25	AION38X-Boost EQ LORC-PCS DS 15AH2-110 27.5"	yes	-	27.5"2.6"	67mm	723mm	160 170	LORC-PCS	AIR (EQ)	44	Al	38	Al	Hard anodized, Black	1.5"to1-1/8" tapered(CTS), Alloy, (OP) 1.8"to1-1/8" tapered(CTS), Alloy	ø15-110	15AH2-110, (OP) 15LH-110	Mg	220 mm	Post 203 Direct		
SF25	AION38X-Boost EQ ABS 2CR-PCS DS 15AH2-110 27.5"	yes	-	27.5"2.6"	67mm	723mm	160 170	2CR-PCS	AIR (EQ)	44	Al	38	Al	Hard anodized, Black	1.5"to1-1/8" tapered(CTS), Alloy, (OP) 1.8"to1-1/8" tapered(CTS), Alloy	ø15-110	15AH2-110, (OP) 15LH-110	Mg	220 mm	Post 203 Direct		
SF25	AION38X-Boost EQ 2CR-PCS DS 15AH2-110 27.5"	yes	-	27.5"2.6"	67mm	723mm	160 170	2CR-PCS	AIR (EQ)	44	Al	38	Al	Hard anodized, Black	1.5"to1-1/8" tapered(CTS), Alloy, (OP) 1.8"to1-1/8" tapered(CTS), Alloy	ø15-110	15AH2-110, (OP) 15LH-110	Mg	220 mm	Post 203 Direct		
SF25	AION38X-Boost EQ ABS RC-PCS DS 15AH2-110 27.5"	yes	-	27.5"2.6"	67mm	723mm	160 170	RC-PCS	AIR (EQ)	44	Al	38	Al	Hard anodized, Black	1.5"to1-1/8" tapered(CTS), Alloy, (OP) 1.8"to1-1/8" tapered(CTS), Alloy	ø15-110	15AH2-110, (OP) 15LH-110	Mg	220 mm	Post 203 Direct		
SF25	AION38X-Boost EQ RC-PCS DS 15AH2-110 27.5"	yes	-	27.5"2.6"	67mm	723mm	160 170	RC-PCS	AIR (EQ)	44	Al	38	Al	Hard anodized, Black	1.5"to1-1/8" tapered(CTS), Alloy, (OP) 1.8"to1-1/8" tapered(CTS), Alloy	ø15-110	15AH2-110, (OP) 15LH-110	Mg	220 mm	Post 203 Direct		

TRAIL / AM

AION38X

SPECIFICATIONS

// 2105

SUNTOUR

# ZERON36X

TRAIL / ALL MOUNTAIN

29"

27.5"

36mm

Boost EQ ABS  
3CR 29"



TRAIL / AM

ZERON36X

MODEL YEAR	MODEL NAME	MAIN SPECIFICATIONS										CROWN			STANCHION		STEERER TUBE		AXLE		BOTTOM CASE / BRAKE		
		E-Bike ready	Weight (g) w/o axle	Wheel / Max. suggested tire size	Max allowed Tire Width	Max allowed Tire O.D.	Travel (mm)	Damper	Spring	Offset (mm)	Mat.	DIA (mm)	Mat.	Finish	Size	Material	O.L.D.	Axle	Mat.	Max rotor DIA	Brake mount		
SF25	ZERON36X-Boost EQ ABS 3CR DS 15AH2-110 29"	yes	-	29"x2.6"	67mm	756mm	120/130 140/150 160	3CR	AIR (EQ)	44	Al	36	Al	Hard anodized, Black	1.5"to1-1/8" tapered(CTS), Alloy, (OP) 1.8"to1-1/8" tapered(CTS), Alloy	ø15-110	15AH2-110, OP) 15LH-110	Mg	220mm	Post 180 Direct			
SF25	ZERON36X-Boost EQ 3CR DS 15AH2-110 29"	yes	-	29"x2.6"	67mm	756mm	120/130 140/150 160	3CR	AIR (EQ)	44	Al	36	Al	Hard anodized, Black	1.5"to1-1/8" tapered(CTS), Alloy, (OP) 1.8"to1-1/8" tapered(CTS), Alloy	ø15-110	15AH2-110, OP) 15LH-110	Mg	220mm	Post 180 Direct			
SF25	ZERON36X-Boost EQ ABS 2CR DS 15AH2-110 29"	yes	-	29"x2.6"	67mm	756mm	120/130 140/150 160	2CR	AIR (EQ)	44	Al	36	Al	Hard anodized, Black	1.5"to1-1/8" tapered(CTS), Alloy, (OP) 1.8"to1-1/8" tapered(CTS), Alloy	ø15-110	15AH2-110, OP) 15LH-110	Mg	220mm	Post 180 Direct			
SF25	ZERON36X-Boost EQ 2CR DS 15AH2-110 29"	yes	-	29"x2.6"	67mm	756mm	120/130 140/150 160	2CR	AIR (EQ)	44	Al	36	Al	Hard anodized, Black	1.5"to1-1/8" tapered(CTS), Alloy, (OP) 1.8"to1-1/8" tapered(CTS), Alloy	ø15-110	15AH2-110, OP) 15LH-110	Mg	220mm	Post 180 Direct			
SF25	ZERON36X-Boost EQ ABS RC DS 15AH2-110 29"	yes	-	29"x2.6"	67mm	756mm	120/130 140/150 160	RC	AIR (EQ)	44	Al	36	Al	Hard anodized, Black	1.5"to1-1/8" tapered(CTS), Alloy, (OP) 1.8"to1-1/8" tapered(CTS), Alloy	ø15-110	15AH2-110, OP) 15LH-110	Mg	220mm	Post 180 Direct			
SF25	ZERON36X-Boost EQ RC DS 15AH2-110 29"	yes	-	29"x2.6"	67mm	756mm	120/130 140/150 160	RC	AIR (EQ)	44	Al	36	Al	Hard anodized, Black	1.5"to1-1/8" tapered(CTS), Alloy, (OP) 1.8"to1-1/8" tapered(CTS), Alloy	ø15-110	15AH2-110, OP) 15LH-110	Mg	220mm	Post 180 Direct			

SPECIFICATIONS

// 2165

SFSAJOUR

# ZERON36X

TRAIL / ALL MOUNTAIN

29"

27.5"

36mm

Boost EQ ABS  
3CR 29"



TRAIL / AM

ZERON36X

MODEL YEAR	MODEL NAME	MAIN SPECIFICATIONS											CROWN			STANCHION			STEERER TUBE		AXLE		BOTTOM CASE / BRAKE		
		E-Bike ready	Weight (g) w/o axle	Wheel / Max. suggested tire size	Max allowed Tire Width	Max allowed Tire O.D.	Travel (mm)	Damper	Spring	Offset (mm)	Mat.	DIA (mm)	Mat.	Finish	Size	Material	O.L.D.	Axle	Mat.	Max rotor DIA	Brake mount				
SF25	ZERON36X-Boost EQ ABS 3CR DS 15AH2-110 27.5"	yes	-	27.5"x2.6"	67mm	723mm	120/130 140/150 160	3CR	AIR (EQ)	44	Al	36	Al	Hard anodized, Black	1.5"to1-1/8" tapered(CTS), Alloy, (OP) 1.8"to1-1/8" tapered(CTS), Alloy	ø15-110	15AH2-110, OP) 15LH-110	Mg	220mm	Post 180 Direct					
SF25	ZERON36X-Boost EQ 3CR DS 15AH2-110 27.5"	yes	-	27.5"x2.6"	67mm	723mm	120/130 140/150 160	3CR	AIR (EQ)	44	Al	36	Al	Hard anodized, Black	1.5"to1-1/8" tapered(CTS), Alloy, (OP) 1.8"to1-1/8" tapered(CTS), Alloy	ø15-110	15AH2-110, OP) 15LH-110	Mg	220mm	Post 180 Direct					
SF25	ZERON36X-Boost EQ ABS 2CR DS 15AH2-110 27.5"	yes	-	27.5"x2.6"	67mm	723mm	120/130 140/150 160	2CR	AIR (EQ)	44	Al	36	Al	Hard anodized, Black	1.5"to1-1/8" tapered(CTS), Alloy, (OP) 1.8"to1-1/8" tapered(CTS), Alloy	ø15-110	15AH2-110, OP) 15LH-110	Mg	220mm	Post 180 Direct					
SF25	ZERON36X-Boost EQ 2CR DS 15AH2-110 27.5"	yes	-	27.5"x2.6"	67mm	723mm	120/130 140/150 160	2CR	AIR (EQ)	44	Al	36	Al	Hard anodized, Black	1.5"to1-1/8" tapered(CTS), Alloy, (OP) 1.8"to1-1/8" tapered(CTS), Alloy	ø15-110	15AH2-110, OP) 15LH-110	Mg	220mm	Post 180 Direct					
SF25	ZERON36X-Boost EQ ABS RC DS 15AH2-110 27.5"	yes	-	27.5"x2.6"	67mm	723mm	120/130 140/150 160	RC	AIR (EQ)	44	Al	36	Al	Hard anodized, Black	1.5"to1-1/8" tapered(CTS), Alloy, (OP) 1.8"to1-1/8" tapered(CTS), Alloy	ø15-110	15AH2-110, OP) 15LH-110	Mg	220mm	Post 180 Direct					
SF25	ZERON36X-Boost EQ RC DS 15AH2-110 27.5"	yes	-	27.5"x2.6"	67mm	723mm	120/130 140/150 160	RC	AIR (EQ)	44	Al	36	Al	Hard anodized, Black	1.5"to1-1/8" tapered(CTS), Alloy, (OP) 1.8"to1-1/8" tapered(CTS), Alloy	ø15-110	15AH2-110, OP) 15LH-110	Mg	220mm	Post 180 Direct					

SPECIFICATIONS

// 2165

SFSAJOUR

# ZERON36

TRAIL / ALL MOUNTAIN

29"

27.5"

36mm

36 Boost EQ 3CR 29"



TRAIL / AM  
ZERON36

		MAIN SPECIFICATIONS										CROWN		STANCHION		STEERER TUBE		AXLE		BOTTOM CASE / BRAKE		
MODEL YEAR	MODEL NAME	E-Bike ready	Weight (g) w/o axle	Wheel / Max. suggested tire size	Max allowed Tire Width	Max allowed Tire O.D.	Travel (mm)	Damper	Spring	Offset (mm)	Mat.	DIA (mm)	Mat.	Finish	Size Material	O.L.D.	Axle	Mat.	Max rotor DIA	Brake mount		
SF25	ZERON36-Boost EQ 3CR DS 15AH2-110 29"	no	-	29"x2.6"	67mm	756mm	120/130 140/150 160	3CR	AIR (EQ)	44	Al	36	Al	Hard anodized, Black	1.5"to1-1/8" tapered(CTS), Alloy, (OP) 1.8"to1-1/8" tapered(CTS), Alloy	ø15-110	15AH2-110, (OP) 15LH-110	Mg	220mm	Post 180 Direct		
SF25	ZERON36-Boost EQ 2CR DS 15AH2-110 29"	no	-	29"x2.6"	67mm	756mm	120/130 140/150 160	2CR	AIR (EQ)	44	Al	36	Al	Hard anodized, Black	1.5"to1-1/8" tapered(CTS), Alloy, (OP) 1.8"to1-1/8" tapered(CTS), Alloy	ø15-110	15AH2-110, (OP) 15LH-110	Mg	220mm	Post 180 Direct		
SF25	ZERON36-Boost EQ RC DS 15AH2-110 29"	no	-	29"x2.6"	67mm	756mm	120/130 140/150 160	RC	AIR (EQ)	44	Al	36	Al	Hard anodized, Black	1.5"to1-1/8" tapered(CTS), Alloy, (OP) 1.8"to1-1/8" tapered(CTS), Alloy	ø15-110	15AH2-110, (OP) 15LH-110	Mg	220mm	Post 180 Direct		
SF25	ZERON36-Boost EQ 3CR DS 15AH2-110 27.5"	no	-	27.5"x2.6"	67mm	723mm	120/130 140/150 160	3CR	AIR (EQ)	44	Al	36	Al	Hard anodized, Black	1.5"to1-1/8" tapered(CTS), Alloy, (OP) 1.8"to1-1/8" tapered(CTS), Alloy	ø15-110	15AH2-110, (OP) 15LH-110	Mg	220mm	Post 180 Direct		
SF25	ZERON36-Boost EQ 2CR DS 15AH2-110 27.5"	no	-	27.5"x2.6"	67mm	723mm	120/130 140/150 160	2CR	AIR (EQ)	44	Al	36	Al	Hard anodized, Black	1.5"to1-1/8" tapered(CTS), Alloy, (OP) 1.8"to1-1/8" tapered(CTS), Alloy	ø15-110	15AH2-110, (OP) 15LH-110	Mg	220mm	Post 180 Direct		
SF25	ZERON36-Boost EQ RC DS 15AH2-110 27.5"	no	-	27.5"x2.6"	67mm	723mm	120/130 140/150 160	RC	AIR (EQ)	44	Al	36	Al	Hard anodized, Black	1.5"to1-1/8" tapered(CTS), Alloy, (OP) 1.8"to1-1/8" tapered(CTS), Alloy	ø15-110	15AH2-110, (OP) 15LH-110	Mg	220mm	Post 180 Direct		

SPECIFICATIONS

// 2105

SFSAIOLR

# AXON34 WERX/ELITE

CROSS COUNTRY

29"

34mm

34 Werx Boost EQ  
RLRC-PCS 29"

34 Elite Boost EQ  
RLRC-PCS 29"



CROSS COUNTRY

AXON34 WERX/ELITE

SPECIFICATIONS

// 2025

MODEL YEAR	MODEL NAME	MAIN SPECIFICATIONS										CROWN		STANCHION		STEERER TUBE		AXLE		BOTTOM CASE / BRAKE		
		E-Bike ready	Weight (g) w/o axle	Wheel / Max. suggested tire size	Max allowed Tire Width	Max allowed Tire O.D.	Travel (mm)	Damper	Spring	Offset (mm)	Mat.	DIA (mm)	Mat.	Finish	Size	Material	O.L.D.	Axle	Mat.	Max rotor DIA	Brake mount	
SF20	AXON34-Werx-Boost EQ RLRC-PCS DS 15QLC2Ti-110 29"	no	-	29"x2.4"	63mm	756mm	100 110 120	RLRC-PCS	AIR (EQ)	51	C	34	Al	Hard anodized, Black	1.5"to1-1/8" tapered(CTS), Carbon	ø15-110	15QLC2Ti-110	Mg	180mm	Post 160 Direct		
SF20	AXON34-Elite-Boost EQ RLRC-PCS DS 15QLC2Ti-110 29"	no	-	29"x2.4"	63mm	756mm	100 110 120	RLRC-PCS	AIR (EQ)	51	Al	34	Al	Hard anodized, Black	1.5"to1-1/8" tapered(CTS), Alloy	ø15-110	15QLC2Ti-110	Mg	180mm	Post 160 Direct		

SF20



34 Boost EQ  
RLRC-PCS 29"



32 Boost  
LORC-PCS 29"



CROSS COUNTRY  
AXON

		MAIN SPECIFICATIONS									CROWN			STANCHION			STEERER TUBE		AXLE		BOTTOM CASE / BRAKE	
MODEL YEAR	MODEL NAME	E-Bike ready	Weight (g) w/o axle	Wheel / Max. suggested tire size	Max allowed Tire Width	Max allowed Tire O.D.	Travel (mm)	Damper	Spring	Offset (mm)	Mat.	DIA (mm)	Mat.	Finish	Size Material	O.L.D.	Axle	Mat.	Max rotor DIA	Brake mount		
SF25	AXON34-Boost EQ RLRC-PCS DS 15AH2-110 29"	no	-	29"x2.4"	63mm	760mm	100/120 130/140	RLRC-PCS	AIR (EQ)	44	Al	34	Al	Hard anodized, Black	1.5"to1-1/8" tapered(CTS), Alloy	ø15-110	15AH2-110, (OP) 15LH-110	Mg	203mm	Post 180 Direct		
SF25	AXON34-Boost EQ LORC-PCS DS 15AH2-110 29"	no	-	29"x2.4"	63mm	760mm	100/120 130/140	LORC-PCS	AIR (EQ)	44	Al	34	Al	Hard anodized, Black	1.5"to1-1/8" tapered(CTS), Alloy	ø15-110	15AH2-110, (OP) 15LH-110	Mg	203mm	Post 180 Direct		
SF19	AXON32-Boost RLRC DS 15QLC2-110 29"	no	1882	29"x2.4"	63mm	756mm	80 100 120	RLRC	AIR	46	Al	32	Al	Hard anodized, Black	1.5"to1-1/8" tapered(CTS), Alloy	ø15-110	15QLC2-110	Mg	180mm	Post 160 Direct		
SF19	AXON32-Boost LORC DS 15QLC2-110 29"	no	1882	29"x2.4"	63mm	756mm	80 100 120	LORC	AIR	46	Al	32	Al	Hard anodized, Black	1.5"to1-1/8" tapered(CTS), Alloy	ø15-110	15QLC2-110	Mg	180mm	Post 160 Direct		
SF19	AXON32-Boost RLRC DS 15QLC2-110 27.5"	no	1892	27.5"x2.6"	66mm	724mm	100 120	RLRC	AIR	42	Al	32	Al	Hard anodized, Black	1.5"to1-1/8" tapered(CTS), Alloy	ø15-110	15QLC2-110	Mg	180mm	Post 160 Direct		
SF19	AXON32-Boost LORC DS 15QLC2-110 27.5"	no	1892	27.5"x2.6"	66mm	724mm	100 120	LORC	AIR	42	Al	32	Al	Hard anodized, Black	1.5"to1-1/8" tapered(CTS), Alloy	ø15-110	15QLC2-110	Mg	180mm	Post 160 Direct		

SPECIFICATIONS  
// 21025  
SHIMANO



# RAIDON34X

TRAIL / CROSS COUNTRY

29"

27.5"

34mm

34X Boost  
EQ 2CR 27.5"



METALLIC-SLATE



GLOSS BLACK



MATT BLACK



GLOSS WHITE

TRAIL / XC

RAIDON34X

MODEL YEAR	MODEL NAME	MAIN SPECIFICATIONS										CROWN		STANCHION		STEERER TUBE		AXLE		BOTTOM CASE / BRAKE		
		E-Bike ready	Weight (g) w/o axle	Wheel / Max. suggested tire size	Max allowed Tire Width	Max allowed Tire O.D.	Travel (mm)	Damper	Spring	Offset (mm)	Mat.	DIA (mm)	Mat.	Finish	Size	Material	O.L.D.	Axle	Mat.	Max rotor DIA	Brake mount	
SF25	RAIDON34X-Boost EQ R-2CR DS 15AH2-110 29"	yes	-	29"x2.4"	63mm	760mm	100 120	R-2CR	AIR (EQ)	51	Al	34	Al	Hard anodized, Black	1.5"to1-1/8" tapered(CTS), Alloy, (OP) 1.8"to1-1/8" tapered(CTS), Alloy	ø15-110	15AH2-110, (OP) 15LH-110	Mg	203mm	Post 180 Direct		
SF25	RAIDON34X-Boost EQ 2CR DS 15AH2-110 29"	yes	-	29"x2.4"	63mm	760mm	100 120	2CR	AIR (EQ)	51	Al	34	Al	Hard anodized, Black	1.5"to1-1/8" tapered(CTS), Alloy, (OP) 1.8"to1-1/8" tapered(CTS), Alloy	ø15-110	15AH2-110, (OP) 15LH-110	Mg	203mm	Post 180 Direct		
SF25	RAIDON34X-Boost EQ R-2CR DS 15AH2-110 27.5"	yes	-	27.5"x2.6"	67mm	725mm	100 120	R-2CR	AIR (EQ)	44	Al	34	Al	Hard anodized, Black	1.5"to1-1/8" tapered(CTS), Alloy, (OP) 1.8"to1-1/8" tapered(CTS), Alloy	ø15-110	15AH2-110, (OP) 15LH-110	Mg	203mm	Post 180 Direct		
SF25	RAIDON34X-Boost EQ 2CR DS 15AH2-110 27.5"	yes	-	27.5"x2.6"	67mm	725mm	100 120	2CR	AIR (EQ)	44	Al	34	Al	Hard anodized, Black	1.5"to1-1/8" tapered(CTS), Alloy, (OP) 1.8"to1-1/8" tapered(CTS), Alloy	ø15-110	15AH2-110, (OP) 15LH-110	Mg	203mm	Post 180 Direct		

SPECIFICATIONS

// 2K25





TRAIL / XC

RAIDON

MODEL YEAR	MODEL NAME	MAIN SPECIFICATIONS										CROWN		STANCHION		STEERER TUBE		AXLE		BOTTOM CASE / BRAKE		
		E-Bike ready	Weight (g) w/o axle	Wheel / Max. suggested tire size	Max allowed Tire Width	Max allowed Tire O.D.	Travel (mm)	Damper	Spring	Offset (mm)	Mat.	DIA (mm)	Mat.	Finish	Size Material	O.L.D.	Axle	Mat.	Max rotor DIA	Brake mount		
SF25	RAIDON34-Boost EQ R-2CR DS 15AH2-110 29"	no	-	29"x2.4"	63mm	760mm	100/120 130/140	R-2CR	AIR (EQ)	44	Al	34	Al	Hard anodized, Black	1.5"to1-1/8" tapered(CTS), Alloy	ø15-110	15AH2-110, (OP) 15LH-110	Mg	203mm	Post 180 Direct		
SF25	RAIDON34-Boost EQ 2CR DS 15AH2-110 29"	no	-	29"x2.4"	63mm	760mm	100/120 130/140	2CR	AIR (EQ)	44	Al	34	Al	Hard anodized, Black	1.5"to1-1/8" tapered(CTS), Alloy	ø15-110	15AH2-110, (OP) 15LH-110	Mg	203mm	Post 180 Direct		
SF25	RAIDON34-Boost EQ R-2CR DS 15AH2-110 27.5"	no	-	27.5"x2.6"	67mm	725mm	100/120 130/140	R-2CR	AIR (EQ)	44	Al	34	Al	Hard anodized, Black	1.5"to1-1/8" tapered(CTS), Alloy	ø15-110	15AH2-110, (OP) 15LH-110	Mg	203mm	Post 180 Direct		
SF25	RAIDON34-Boost EQ 2CR DS 15AH2-110 27.5"	no	-	27.5"x2.6"	67mm	725mm	100/120 130/140	2CR	AIR (EQ)	44	Al	34	Al	Hard anodized, Black	1.5"to1-1/8" tapered(CTS), Alloy	ø15-110	15AH2-110, (OP) 15LH-110	Mg	203mm	Post 180 Direct		
SF25	RAIDON34-JR-Boost EQ 2CR DS 15AH2-110 24"	no	-	24"x2.6"	68mm	640mm	100 120	2CR	AIR (EQ)	44	Al	34	Al	Hard anodized, Black	1.5"to1-1/8" tapered(CTS), Alloy	ø15-110	15AH2-110, (OP) 15LH-110	Mg	203mm	Post 180 Direct		
SF25	RAIDON34-JR-Boost EQ 2CR DS 15AH2-110 20"	no	-	20"x2.6"	68mm	539mm	100	2CR	AIR (EQ)	44	Al	34	Al	Hard anodized, Black	1.5"to1-1/8" tapered(CTS), Alloy	ø15-110	15AH2-110, (OP) 15LH-110	Mg	203mm	Post 180 Direct		
SF19	RAIDON32-Boost RLR DS 15QLC32-110 29"	no	2020	29"x2.4"	63mm	756mm	80/100 120	RLR	AIR	46	Al	32	Al	Hard anodized, Black	1.5"to1-1/8" tapered(CTS), Alloy	ø15-110	15QLC32-110	Mg	180mm	Post 160 Direct		
SF19	RAIDON32-Boost LOR DS 15QLC32-110 29"	no	2020	29"x2.4"	63mm	756mm	80/100 120	LOR	AIR	46	Al	32	Al	Hard anodized, Black	1.5"to1-1/8" tapered(CTS), Alloy	ø15-110	15QLC32-110	Mg	180mm	Post 160 Direct		
SF19	RAIDON32-Boost RLR DS 15QLC32-110 27.5"	no	2025	27.5"x2.5"	66mm	724mm	100 120	RLR	AIR	42	Al	32	Al	Hard anodized, Black	1.5"to1-1/8" tapered(CTS), Alloy	ø15-110	15QLC32-110	Mg	180mm	Post 160 Direct		
SF19	RAIDON32-Boost LOR DS 15QLC32-110 27.5"	no	2019	27.5"x2.5"	66mm	724mm	100 120	LOR	AIR	42	Al	32	Al	Hard anodized, Black	1.5"to1-1/8" tapered(CTS), Alloy	ø15-110	15QLC32-110	Mg	180mm	Post 160 Direct		

SPECIFICATIONS

// 2025

SFSAIOTOR

34 Boost  
R-2CR AIR 27.5"

34 JR Boost  
2CR AIR 24"



GLOSS BLACK

MATT BLACK

GLOSS WHITE

MODEL YEAR	MODEL NAME	MAIN SPECIFICATIONS										CROWN			STANCHION			STEERER TUBE		AXLE		BOTTOM CASE / BRAKE		
		E-Bike ready	Weight (g) w/o axle	Wheel / Max. suggested tire size	Max allowed Tire Width	Max allowed Tire O.D.	Travel (mm)	Damper	Spring	Offset (mm)	Mat.	DIA (mm)	Mat.	Finish	Size Material	O.L.D.	Axle	Mat.	Max rotor DIA	Brake mount				
SF25	XCR34-Boost AIR R-2CR DS 15AH2-110 29"	no	-	29"x2.4"	63mm	760mm	100/120 130/140	R-2CR	AIR	44	Al	34	STKM	Black	1.5"to1-1/8" tapered(CTS), Alloy	ø15-110	15AH2-110, (OP) 15LH-110	Mg	203mm	Post 180 Direct				
SF25	XCR34-Boost AIR 2CR DS 15AH2-110 29"	no	-	29"x2.4"	63mm	760mm	100/120 130/140	2CR	AIR	44	Al	34	STKM	Black	1.5"to1-1/8" tapered(CTS), Alloy	ø15-110	15AH2-110, (OP) 15LH-110	Mg	203mm	Post 180 Direct				
SF25	XCR34-Boost AIR R-2CR DS 15AH2-110 27.5"	no	-	27.5"x2.6"	67mm	725mm	100/120 130/140	R-2CR	AIR	44	Al	34	STKM	Black	1.5"to1-1/8" tapered(CTS), Alloy	ø15-110	15AH2-110, (OP) 15LH-110	Mg	203mm	Post 180 Direct				
SF25	XCR34-Boost AIR 2CR DS 15AH2-110 27.5"	no	-	27.5"x2.6"	67mm	725mm	100/120 130/140	2CR	AIR	44	Al	34	STKM	Black	1.5"to1-1/8" tapered(CTS), Alloy	ø15-110	15AH2-110, (OP) 15LH-110	Mg	203mm	Post 180 Direct				
SF25	XCR34-JR-Boost AIR 2CR DS 15AH2-110 24"	no	-	24"x2.6"	68mm	640mm	80/100	2CR	AIR	44	Al	34	STKM	Black	1.5"to1-1/8" tapered(CTS), Alloy	ø15-110	15AH2-110, (OP) 15LH-110	Mg	203mm	Post 180 Direct				

# XCR34X

CROSS COUNTRY

29"

27.5"

34mm

34X Boost AIR  
2CR 27.5"



GLOSS BLACK

MATT BLACK

GLOSS WHITE

CROSS COUNTRY

XCR34X

		MAIN SPECIFICATIONS									CROWN		STANCHION		STEERER TUBE		AXLE		BOTTOM CASE / BRAKE	
MODEL YEAR	MODEL NAME	E-Bike ready	Weight (g) w/o axle	Wheel / Max. suggested tire size	Max allowed Tire Width	Max allowed Tire O.D.	Travel (mm)	Damper	Spring	Offset (mm)	Mat.	DIA (mm)	Mat.	Finish	Size Material	O.L.D.	Axle	Mat.	Max rotor DIA	Brake mount
SF25	XCR34X-Boost AIR R-2CR DS 15AH2-110 29"	yes	-	29"x2.4"	63mm	760mm	100/120	R-2CR	AIR	51	Al	34	STKM	Black	1.5"to1-1/8" tapered(CTS), Alloy, (OP) 1.8"to1-1/8" tapered(CTS), Alloy	ø15-110	15AH2-110, (OP) 15LH-110	Mg	203mm	Post 180 Direct
SF25	XCR34X-Boost AIR 2CR DS 15AH2-110 29"	yes	-	29"x2.4"	63mm	760mm	100/120	2CR	AIR	51	Al	34	STKM	Black	1.5"to1-1/8" tapered(CTS), Alloy, (OP) 1.8"to1-1/8" tapered(CTS), Alloy	ø15-110	15AH2-110, (OP) 15LH-110	Mg	203mm	Post 180 Direct
SF25	XCR34X-Boost COIL R-2CR DS 15AH2-110 29"	yes	-	29"x2.4"	63mm	760mm	100/120	R-2CR	COIL w/ Preload adjuster	51	Al	34	STKM	Black	1.5"to1-1/8" tapered(CTS), Alloy, (OP) 1.8"to1-1/8" tapered(CTS), Alloy	ø15-110	15AH2-110, (OP) 15LH-110	Mg	203mm	Post 180 Direct
SF25	XCR34X-Boost COIL 2CR DS 15AH2-110 29"	yes	-	29"x2.4"	63mm	760mm	100/120	2CR	COIL w/ Preload adjuster	51	Al	34	STKM	Black	1.5"to1-1/8" tapered(CTS), Alloy, (OP) 1.8"to1-1/8" tapered(CTS), Alloy	ø15-110	15AH2-110, (OP) 15LH-110	Mg	203mm	Post 180 Direct
SF25	XCR34X-Boost AIR R-2CR DS 15AH2-110 27.5"	yes	-	27.5"x2.6"	67mm	725mm	100/120	R-2CR	AIR	44	Al	34	STKM	Black	1.5"to1-1/8" tapered(CTS), Alloy, (OP) 1.8"to1-1/8" tapered(CTS), Alloy	ø15-110	15AH2-110, (OP) 15LH-110	Mg	203mm	Post 180 Direct
SF25	XCR34X-Boost AIR 2CR DS 15AH2-110 27.5"	yes	-	27.5"x2.6"	67mm	725mm	100/120	2CR	AIR	44	Al	34	STKM	Black	1.5"to1-1/8" tapered(CTS), Alloy, (OP) 1.8"to1-1/8" tapered(CTS), Alloy	ø15-110	15AH2-110, (OP) 15LH-110	Mg	203mm	Post 180 Direct
SF25	XCR34X-Boost COIL R-2CR DS 15AH2-110 27.5"	yes	-	27.5"x2.6"	67mm	725mm	100/120	R-2CR	COIL w/ Preload adjuster	44	Al	34	STKM	Black	1.5"to1-1/8" tapered(CTS), Alloy, (OP) 1.8"to1-1/8" tapered(CTS), Alloy	ø15-110	15AH2-110, (OP) 15LH-110	Mg	203mm	Post 180 Direct
SF25	XCR34X-Boost COIL 2CR DS 15AH2-110 27.5"	yes	-	27.5"x2.6"	67mm	725mm	100/120	2CR	COIL w/ Preload adjuster	44	Al	34	STKM	Black	1.5"to1-1/8" tapered(CTS), Alloy, (OP) 1.8"to1-1/8" tapered(CTS), Alloy	ø15-110	15AH2-110, (OP) 15LH-110	Mg	203mm	Post 180 Direct

SPECIFICATIONS

// 2025

SFSAUNOR



MODEL YEAR	MODEL NAME	MAIN SPECIFICATIONS									CROWN		STANCHION		STEERER TUBE		AXLE		BOTTOM CASE / BRAKE		
		E-Bike ready	Weight (g) w/o axle	Wheel / Max. suggested tire size	Max allowed Tire Width	Max allowed Tire O.D.	Travel (mm)	Damper	Spring	Offset (mm)	Mat.	DIA (mm)	Mat.	Finish	Size Material	O.L.D.	Axle	Mat.	Max rotor DIA	Brake mount	
SF19	XCR32-Boost AIR RLR DS 15QLC32-110 29"	no	2320	29"x2.4"	63mm	756mm	80 100 120	RLR	AIR	46	Al	32	STKM	Black	1.5"to1-1/8" tapered(CTS), Alloy	ø15-110	15QLC32-110	Mg	180mm	Post 160 Direct	
SF19	XCR32-Boost AIR LOR DS 15QLC32-110 29"	no	2317	29"x2.4"	63mm	756mm	80 100 120	LOR	AIR	46	Al	32	STKM	Black	1.5"to1-1/8" tapered(CTS), Alloy	ø15-110	15QLC32-110	Mg	180mm	Post 160 Direct	
SF19	XCR32-Boost COIL RLR DS 15QLC32-110 29"	no	2358	29"x2.4"	63mm	756mm	80 100 120	RLR	COIL w/ Preload adjuster	46	Al	32	STKM	Black	1.5"to1-1/8" tapered(CTS), Alloy	ø15-110	15QLC32-110	Mg	180mm	Post 160 Direct	
SF19	XCR32-Boost COIL LOR DS 15QLC32-110 29"	no	2354	29"x2.4"	63mm	756mm	80 100 120	LOR	COIL w/ Preload adjuster	46	Al	32	STKM	Black	1.5"to1-1/8" tapered(CTS), Alloy	ø15-110	15QLC32-110	Mg	180mm	Post 160 Direct	
SF19	XCR32-Boost COIL RL DS 15QLC32-110 29"	no	2357	29"x2.4"	63mm	756mm	80 100 120	RL	COIL w/ Preload adjuster	46	Al	32	STKM	Black	1.5"to1-1/8" tapered(CTS), Alloy	ø15-110	15QLC32-110	Mg	180mm	Post 160 Direct	
SF19	XCR32-Boost COIL LO DS 15QLC32-110 29"	no	2353	29"x2.4"	63mm	756mm	80 100 120	LO	COIL w/ Preload adjuster	46	Al	32	STKM	Black	1.5"to1-1/8" tapered(CTS), Alloy	ø15-110	15QLC32-110	Mg	180mm	Post 160 Direct	
SF19	XCR32-Boost AIR RLR DS 15QLC32-110 27.5"	no	2318	27.5"x2.5"	66mm	724mm	100 120	RLR	AIR	42	Al	32	STKM	Black	1.5"to1-1/8" tapered(CTS), Alloy	ø15-110	15QLC32-110	Mg	180mm	Post 160 Direct	
SF19	XCR32-Boost AIR LOR DS 15QLC32-110 27.5"	no	2315	27.5"x2.5"	66mm	724mm	100 120	LOR	AIR	42	Al	32	STKM	Black	1.5"to1-1/8" tapered(CTS), Alloy	ø15-110	15QLC32-110	Mg	180mm	Post 160 Direct	
SF19	XCR32-Boost COIL RLR DS 15QLC32-110 27.5"	no	2357	27.5"x2.5"	66mm	724mm	100 120	RLR	COIL w/ Preload adjuster	42	Al	32	STKM	Black	1.5"to1-1/8" tapered(CTS), Alloy	ø15-110	15QLC32-110	Mg	180mm	Post 160 Direct	
SF19	XCR32-Boost COIL LOR DS 15QLC32-110 27.5"	no	2353	27.5"x2.5"	66mm	724mm	100 120	LOR	COIL w/ Preload adjuster	42	Al	32	STKM	Black	1.5"to1-1/8" tapered(CTS), Alloy	ø15-110	15QLC32-110	Mg	180mm	Post 160 Direct	
SF19	XCR32-Boost COIL RL DS 15QLC32-110 27.5"	no	2356	27.5"x2.5"	66mm	724mm	100 120	RL	COIL w/ Preload adjuster	42	Al	32	STKM	Black	1.5"to1-1/8" tapered(CTS), Alloy	ø15-110	15QLC32-110	Mg	180mm	Post 160 Direct	
SF19	XCR32-Boost COIL LO DS 15QLC32-110 27.5"	no	2352	27.5"x2.5"	66mm	724mm	100 120	LO	COIL w/ Preload adjuster	42	Al	32	STKM	Black	1.5"to1-1/8" tapered(CTS), Alloy	ø15-110	15QLC32-110	Mg	180mm	Post 160 Direct	

# XCR32-ATB

CROSS COUNTRY

29"

27.5"

32mm

XCR32 ATB LO 29"



CROSS COUNTRY

XCR32-ATB

SPECIFICATIONS

// 21025

SFSAINTOUR

		MAIN SPECIFICATIONS										CROWN			STANCHION			STEERER TUBE		AXLE		BOTTOM CASE / BRAKE	
MODEL YEAR	MODEL NAME	E-Bike ready	Weight (g) w/o axle	Wheel / Max. suggested tire size	Max allowed Tire Width	Max allowed Tire O.D.	Travel (mm)	Damper	Spring	Offset (mm)	Mat.	DIA (mm)	Mat.	Finish	Size Material	O.L.D.	Axle	Mat.	Max rotor DIA	Brake mount			
SF24	XCR32-ATB AIR RLR DS 29"	no	2580	29"x2.4"	54mm	630mm	80/100	RLR	AIR	44	Al	32	STKM	Black	1.5"to1-1/8" tapered(CTS), STKM	9-100	9mm-Dropout	Mg	180mm	Post 160 Direct			
SF24	XCR32-ATB AIR LOR DS 29"	no	2580	29"x2.4"	54mm	630mm	80/100	LOR	AIR	44	Al	32	STKM	Black	1.5"to1-1/8" tapered(CTS), STKM	9-100	9mm-Dropout	Mg	180mm	Post 160 Direct			
SF21	XCR32-ATB RLR DS 29"	no	-	29"x2.4"	58mm	530mm	80/100	RLR	COIL w/ Preload adjuster	44	Al	32	STKM	Black	1.5"to1-1/8" tapered(CTS), STKM, (OP) 1.5"to1-1/8" tapered(CTS), Alloy	9-100	9mm-Dropout	Mg	180mm	Post 160 Direct			
SF21	XCR32-ATB LOR DS 29"	no	-	29"x2.4"	58mm	530mm	80/100	LOR	COIL w/ Preload adjuster	44	Al	32	STKM	Black	1.5"to1-1/8" tapered(CTS), STKM, (OP) 1.5"to1-1/8" tapered(CTS), Alloy	9-100	9mm-Dropout	Mg	180mm	Post 160 Direct			
SF21	XCR32-ATB RL DS 29"	no	-	29"x2.4"	64mm	758mm	80/100	RL	COIL w/ Preload adjuster	44	Al	32	STKM	Black	1.5"to1-1/8" tapered(CTS), STKM, (OP) 1.5"to1-1/8" tapered(CTS), Alloy	9-100	9mm-Dropout	Mg	180mm	Post 160 Direct			
SF21	XCR32-ATB LO DS 29"	no	-	29"x2.4"	64mm	758mm	80/100	LO	COIL w/ Preload adjuster	44	Al	32	STKM	Black	1.5"to1-1/8" tapered(CTS), STKM, (OP) 1.5"to1-1/8" tapered(CTS), Alloy	9-100	9mm-Dropout	Mg	180mm	Post 160 Direct			
SF24	XCR32-ATB AIR RLR DS 27.5"	no	-	27.5"x2.4"	56mm	526mm	80/100	RLR	AIR	44	Al	32	STKM	Black	1.5"to1-1/8" tapered(CTS), STKM	9-100	9mm-Dropout	Mg	180mm	Post 160 Direct			
SF24	XCR32-ATB AIR LOR DS 27.5"	no	-	27.5"x2.4"	56mm	526mm	80/100	LOR	AIR	44	Al	32	STKM	Black	1.5"to1-1/8" tapered(CTS), STKM	9-100	9mm-Dropout	Mg	180mm	Post 160 Direct			
SF21	XCR32-ATB RLR DS 27.5"	no	-	27.5"x2.4"	64mm	718mm	80/100	RLR	COIL w/ Preload adjuster	44	Al	32	STKM	Black	1.5"to1-1/8" tapered(CTS), STKM, (OP) 1.5"to1-1/8" tapered(CTS), Alloy	9-100	9mm-Dropout	Mg	180mm	Post 160 Direct			
SF21	XCR32-ATB LOR DS 27.5"	no	-	27.5"x2.4"	64mm	718mm	80/100	LOR	COIL w/ Preload adjuster	44	Al	32	STKM	Black	1.5"to1-1/8" tapered(CTS), STKM, (OP) 1.5"to1-1/8" tapered(CTS), Alloy	9-100	9mm-Dropout	Mg	180mm	Post 160 Direct			
SF21	XCR32-ATB RL DS 27.5"	no	-	27.5"x2.4"	64mm	758mm	80/100	RL	COIL w/ Preload adjuster	44	Al	32	STKM	Black	1.5"to1-1/8" tapered(CTS), STKM, (OP) 1.5"to1-1/8" tapered(CTS), Alloy	9-100	9mm-Dropout	Mg	180mm	Post 160 Direct			
SF21	XCR32-ATB LO DS 27.5"	no	-	27.5"x2.4"	64mm	758mm	80/100	LO	COIL w/ Preload adjuster	44	Al	32	STKM	Black	1.5"to1-1/8" tapered(CTS), STKM, (OP) 1.5"to1-1/8" tapered(CTS), Alloy	9-100	9mm-Dropout	Mg	180mm	Post 160 Direct			

# EPIXON32

CROSS COUNTRY

29"

27.5"

32mm

32 AIR 2CR 29"



CROSS COUNTRY

EPIXON32

SPECIFICATIONS

// 2105

SFSAJOUR

MODEL YEAR	MODEL NAME	MAIN SPECIFICATIONS									CROWN		STANCHION		STEERER TUBE	AXLE		BOTTOM CASE / BRAKE		
		E-Bike ready	Weight (g) w/o axle	Wheel / Max. suggested tire size	Max allowed Tire Width	Max allowed Tire O.D.	Travel (mm)	Damper	Spring	Offset (mm)	Mat.	DIA (mm)	Mat.	Finish	Size Material	O.L.D.	Axle	Mat.	Max rotor DIA	Brake mount
SF24	EPIXON32 AIR R-2CR DS 29"	no	-	29"x2.4"	54mm	630mm	80 100 120	R-2CR	AIR	44	Al	32	Al	Hard anodized, Black	1.5"to 1-1/8" tapered(CTS), Alloy	9-100	9mm-Dropout	Mg	180mm	Post 160 Direct
SF24	EPIXON32 AIR 2CR DS 29"	no	-	29"x2.4"	54mm	630mm	80 100 120	2CR	AIR	44	Al	32	Al	Hard anodized, Black	1.5"to 1-1/8" tapered(CTS), Alloy	9-100	9mm-Dropout	Mg	180mm	Post 160 Direct
SF24	EPIXON32 AIR R-2CR DS 27.5"	no	-	27.5"x2.4"	56mm	526mm	80 100 120	R-2CR	AIR	44	Al	32	Al	Hard anodized, Black	1.5"to 1-1/8" tapered(CTS), Alloy	9-100	9mm-Dropout	Mg	180mm	Post 160 Direct
SF24	EPIXON32 AIR 2CR DS 27.5"	no	-	27.5"x2.4"	56mm	526mm	80 100 120	2CR	AIR	44	Al	32	Al	Hard anodized, Black	1.5"to 1-1/8" tapered(CTS), Alloy	9-100	9mm-Dropout	Mg	180mm	Post 160 Direct

32 Boost AIR LOR 29"



GLOSS BLACK

MATT BLACK

GLOSS WHITE

TRAIL / XC

X1

SPECIFICATIONS

// 2025



MODEL YEAR	MODEL NAME	MAIN SPECIFICATIONS									CROWN		STANCHION		STEERER TUBE	AXLE		BOTTOM CASE / BRAKE	
		E-Bike ready	Weight (g) w/o axle	Wheel / Max. suggested tire size	Max allowed Tire Width	Max allowed Tire O.D.	Travel (mm)	Damper	Spring	Offset (mm)	Mat.	DIA (mm)	Finish	Size Material	O.L.D.	Axle	Mat.	Max rotor DIA	Brake mount
SF23	X1-Boost Air RLR DS 15AH2-110 29"	yes	-	29"x2.4"	63mm	760mm	100 120	RLR	AIR	44	Al	32	STKM	1.5"to1-1/8" tapered(CTS), Alloy, (OP) 1.5" staight, Alloy	ø15-110	15AH2-110	Al	203mm	Post 180 Direct
SF23	X1-Boost Air LOR DS 15AH2-110 29"	yes	-	29"x2.4"	63mm	760mm	100 120	LOR	AIR	44	Al	32	STKM	1.5"to1-1/8" tapered(CTS), Alloy, (OP) 1.5" staight, Alloy	ø15-110	15AH2-110	Al	203mm	Post 180 Direct
SF23	X1-Boost Air RLR DS 15AH2-110 27.5"	yes	-	27.5"x2.6"	67mm	725mm	100 120	RLR	AIR	44	Al	32	STKM	1.5"to1-1/8" tapered(CTS), Alloy, (OP) 1.5" staight, Alloy	ø15-110	15AH2-110	Al	203mm	Post 180 Direct
SF23	X1-Boost Air LOR DS 15AH2-110 27.5"	yes	-	27.5"x2.6"	67mm	725mm	100 120	LOR	AIR	44	Al	32	STKM	1.5"to1-1/8" tapered(CTS), Alloy, (OP) 1.5" staight, Alloy	ø15-110	15AH2-110	Al	203mm	Post 180 Direct



35 Boost COIL  
RLR 29"



GLOSS BLACK



MATT BLACK



GLOSS WHITE

TRAIL / XC

X1

MODEL YEAR	MODEL NAME	MAIN SPECIFICATIONS										CROWN		STANCHION		STEERER TUBE		AXLE		BOTTOM CASE / BRAKE		
		E-Bike ready	Weight (g) w/o axle	Wheel / Max. suggested tire size	Max allowed Tire Width	Max allowed Tire O.D.	Travel (mm)	Damper	Spring	Offset (mm)	Mat.	DIA (mm)	Finish	Size Material	O.L.D.	Axle	Mat.	Max rotor DIA	Brake mount			
SF22	X1-COIL RLR DS 29"	no	-	29"x2.25"	58mm	754mm	80 100	RLR	COIL w/ Preload adjuster	46	Al	32	Black	1-1/8"(TS), Alloy, (OP) 1.5"to1-1/8" tapered(CTS), Alloy	9-100	9mm-Dropout	Al	180mm	Post 160 Direct			
SF22	X1-COIL LOR DS 29"	no	-	29"x2.25"	58mm	754mm	80 100	LOR	COIL w/ Preload adjuster	46	Al	32	STKM	1-1/8"(TS), Alloy, (OP) 1.5"to1-1/8" tapered(CTS), Alloy	9-100	9mm-Dropout	Al	180mm	Post 160 Direct			
SF22	X1-COIL RL DS 29"	no	-	29"x2.25"	58mm	754mm	80 100	RL	COIL w/ Preload adjuster	46	Al	32	STKM	1-1/8"(TS), Alloy, (OP) 1.5"to1-1/8" tapered(CTS), Alloy	9-100	9mm-Dropout	Al	180mm	Post 160 Direct			
SF22	X1-COIL LO DS 29"	no	-	29"x2.25"	58mm	754mm	80 100	LO	COIL w/ Preload adjuster	46	Al	32	STKM	1-1/8"(TS), Alloy, (OP) 1.5"to1-1/8" tapered(CTS), Alloy	9-100	9mm-Dropout	Al	180mm	Post 160 Direct			
SF22	X1-COIL RLR DS 27.5"	no	-	27.5"x2.25"	58mm	710mm	100 120	RLR	COIL w/ Preload adjuster	42	Al	32	STKM	1-1/8"(TS), Alloy, (OP) 1.5"to1-1/8" tapered(CTS), Alloy	9-100	9mm-Dropout	Al	180mm	Post 160 Direct			
SF22	X1-COIL LOR DS 27.5"	no	-	27.5"x2.25"	58mm	710mm	100 120	LOR	COIL w/ Preload adjuster	42	Al	32	STKM	1-1/8"(TS), Alloy, (OP) 1.5"to1-1/8" tapered(CTS), Alloy	9-100	9mm-Dropout	Al	180mm	Post 160 Direct			
SF22	X1-COIL RL DS 27.5"	no	-	27.5"x2.25"	58mm	710mm	100 120	RL	COIL w/ Preload adjuster	42	Al	32	STKM	1-1/8"(TS), Alloy, (OP) 1.5"to1-1/8" tapered(CTS), Alloy	9-100	9mm-Dropout	Al	180mm	Post 160 Direct			
SF22	X1-COIL LO DS 27.5"	no	-	27.5"x2.25"	58mm	710mm	100 120	LO	COIL w/ Preload adjuster	42	Al	32	STKM	1-1/8"(TS), Alloy, (OP) 1.5"to1-1/8" tapered(CTS), Alloy	9-100	9mm-Dropout	Al	180mm	Post 160 Direct			

SPECIFICATIONS

// 21025

SUNTOUR

34 Boost LOR 29"



GLOSS BLACK

MATT BLACK

GLOSS WHITE

MODEL YEAR	MODEL NAME	MAIN SPECIFICATIONS										CROWN			STANCHION		STEERER TUBE		AXLE		BOTTOM CASE / BRAKE		
		E-Bike ready	Weight (g) w/o axle	Wheel / Max. suggested tire size	Max allowed Tire Width	Max allowed Tire O.D.	Travel (mm)	Damper	Spring	Offset (mm)	Mat.	DIA (mm)	Mat.	Finish	Size	Material	O.L.D.	Axle	Mat.	Max rotor DIA	Brake mount		
SF19	XCM34-Boost LOR DS 15AH2-110 29"	yes	3420	29"x2.4"	63mm	756mm	100 120 130	LOR	COIL w/ Preload adjuster	51	Al	34	STKM	Cr-plating	1.5"to1-1/8" tapered(CTS), STKM	Al	15AH2-110, (OP) 15QLC32-110	Al	203mm	Post 160 Direct			
SF19	XCM34-Boost RL DS 15AH2-110 29"	yes	3420	29"x2.4"	63mm	756mm	100 120 130	RL	COIL w/ Preload adjuster	51	Al	34	STKM	Cr-plating	1.5"to1-1/8" tapered(CTS), STKM	Al	15AH2-110, (OP) 15QLC32-110	Al	203mm	Post 160 Direct			
SF19	XCM34-Boost LO DS 15AH2-110 29"	yes	3420	29"x2.4"	63mm	756mm	100 120 130	LO	COIL w/ Preload adjuster	51	Al	34	STKM	Cr-plating	1.5"to1-1/8" tapered(CTS), STKM	Al	15AH2-110, (OP) 15QLC32-110	Al	203mm	Post 160 Direct			
SF19	XCM34-Boost NLO DS 15AH2-110 29"	yes	3420	29"x2.4"	63mm	756mm	100 120 130	NLO	COIL w/ Preload adjuster	51	Al	34	STKM	Cr-plating	1.5"to1-1/8" tapered(CTS), STKM	Al	15AH2-110, (OP) 15QLC32-110	Al	203mm	Post 160 Direct			
SF19	XCM34-Boost DS 15AH2-110 29"	yes	3420	29"x2.4"	63mm	756mm	100 120 130	-	COIL w/ Preload adjuster	51	Al	34	STKM	Cr-plating	1.5"to1-1/8" tapered(CTS), STKM	Al	15AH2-110, (OP) 15QLC32-110	Al	203mm	Post 160 Direct			
SF19	XCM34-Boost LOR DS 15AH2-110 27.5"	yes	3380	27.5"x3.0"	78mm	740mm	100 120 130	LOR	COIL w/ Preload adjuster	47	Al	34	STKM	Cr-plating	1.5"to1-1/8" tapered(CTS), STKM	Al	15AH2-110, (OP) 15QLC32-110	Al	203mm	Post 160 Direct			
SF19	XCM34-Boost RL DS 15AH2-110 27.5"	yes	3380	27.5"x3.0"	78mm	740mm	100 120 130	RL	COIL w/ Preload adjuster	47	Al	34	STKM	Cr-plating	1.5"to1-1/8" tapered(CTS), STKM	Al	15AH2-110, (OP) 15QLC32-110	Al	203mm	Post 160 Direct			
SF19	XCM34-Boost LO DS 15AH2-110 27.5"	yes	3380	27.5"x3.0"	78mm	740mm	100 120 130	LO	COIL w/ Preload adjuster	47	Al	34	STKM	Cr-plating	1.5"to1-1/8" tapered(CTS), STKM	Al	15AH2-110, (OP) 15QLC32-110	Al	203mm	Post 160 Direct			
SF19	XCM34-Boost NLO DS 15AH2-110 27.5"	yes	3380	27.5"x3.0"	78mm	740mm	100 120 130	NLO	COIL w/ Preload adjuster	47	Al	34	STKM	Cr-plating	1.5"to1-1/8" tapered(CTS), STKM	Al	15AH2-110, (OP) 15QLC32-110	Al	203mm	Post 160 Direct			
SF19	XCM34-Boost DS 15AH2-110 27.5"	yes	3380	27.5"x3.0"	78mm	740mm	100 120 130	-	COIL w/ Preload adjuster	47	Al	34	STKM	Cr-plating	1.5"to1-1/8" tapered(CTS), STKM	Al	15AH2-110, (OP) 15QLC32-110	Al	203mm	Post 160 Direct			

32 Boost LOR 29"



MODEL YEAR	MODEL NAME	MAIN SPECIFICATIONS										CROWN		STANCHION		STEERER TUBE		AXLE		BOTTOM CASE / BRAKE		
		E-Bike ready	Weight (g) w/o axle	Wheel / Max. suggested tire size	Max allowed Tire Width	Max allowed Tire O.D.	Travel (mm)	Damper	Spring	Offset (mm)	Mat.	DIA (mm)	Mat.	Finish	Size Material	O.L.D.	Axle	Mat.	Max rotor DIA	Brake mount		
SF20	XCM32-Boost LOR DS 15AH2-110 29"	yes	3330	29"x2.4"	63mm	752mm	80 100 120	LOR	COIL w/ Preload adjuster	51	Al	32	STKM	Cr-plating	1.5"to1-1/8" tapered(CTS), STKM	ø15-110	15AH2-110, (OP) 15QLC32-110	Al	180mm	Post 160 Direct		
SF20	XCM32-Boost RL DS 15AH2-110 29"	yes	3330	29"x2.4"	63mm	752mm	80 100 120	RL	COIL w/ Preload adjuster	51	Al	32	STKM	Cr-plating	1.5"to1-1/8" tapered(CTS), STKM	ø15-110	15AH2-110, (OP) 15QLC32-110	Al	180mm	Post 160 Direct		
SF20	XCM32-Boost LO DS 15AH2-110 29"	yes	3330	29"x2.4"	63mm	752mm	80 100 120	LO	COIL w/ Preload adjuster	51	Al	32	STKM	Cr-plating	1.5"to1-1/8" tapered(CTS), STKM	ø15-110	15AH2-110, (OP) 15QLC32-110	Al	180mm	Post 160 Direct		
SF20	XCM32-Boost NLO DS 15AH2-110 29"	yes	3330	29"x2.4"	63mm	752mm	80 100 120	NLO	COIL w/ Preload adjuster	51	Al	32	STKM	Cr-plating	1.5"to1-1/8" tapered(CTS), STKM	ø15-110	15AH2-110, (OP) 15QLC32-110	Al	180mm	Post 160 Direct		
SF20	XCM32-Boost DS 15AH2-110 29"	yes	3330	29"x2.4"	63mm	752mm	80 100 120	-	COIL w/ Preload adjuster	51	Al	32	STKM	Cr-plating	1.5"to1-1/8" tapered(CTS), STKM	ø15-110	15AH2-110, (OP) 15QLC32-110	Al	180mm	Post 160 Direct		
SF19	XCM32-Boost LOR DS 15AH2-110 27.5"	yes	3280	27.5"x2.6"	63mm	752mm	80 100 120	LOR	COIL w/ Preload adjuster	47	Al	32	STKM	Cr-plating	1.5"to1-1/8" tapered(CTS), STKM	ø15-110	15AH2-110, (OP) 15QLC32-110	Al	180mm	Post 160 Direct		
SF19	XCM32-Boost RL DS 15AH2-110 27.5"	yes	3280	27.5"x2.6"	67mm	730mm	80 100 120	RL	COIL w/ Preload adjuster	47	Al	32	STKM	Cr-plating	1.5"to1-1/8" tapered(CTS), STKM	ø15-110	15AH2-110, (OP) 15QLC32-110	Al	180mm	Post 160 Direct		
SF19	XCM32-Boost LO DS 15AH2-110 27.5"	yes	3280	27.5"x2.6"	67mm	730mm	80 100 120	LO	COIL w/ Preload adjuster	47	Al	32	STKM	Cr-plating	1.5"to1-1/8" tapered(CTS), STKM	ø15-110	15AH2-110, (OP) 15QLC32-110	Al	180mm	Post 160 Direct		
SF19	XCM32-Boost NLO DS 15AH2-110 27.5"	yes	3280	27.5"x2.6"	67mm	730mm	80 100 120	NLO	COIL w/ Preload adjuster	47	Al	32	STKM	Cr-plating	1.5"to1-1/8" tapered(CTS), STKM	ø15-110	15AH2-110, (OP) 15QLC32-110	Al	180mm	Post 160 Direct		
SF19	XCM32-Boost DS 15AH2-110 27.5"	yes	3280	27.5"x2.6"	67mm	730mm	80 100 120	-	COIL w/ Preload adjuster	47	Al	32	STKM	Cr-plating	1.5"to1-1/8" tapered(CTS), STKM	ø15-110	15AH2-110, (OP) 15QLC32-110	Al	180mm	Post 160 Direct		



		MAIN SPECIFICATIONS										CROWN		STANCHION		STEERER TUBE		AXLE		BOTTOM CASE / BRAKE	
MODEL YEAR	MODEL NAME	E-Bike ready	Weight (g) w/o axle	Wheel / Max. suggested tire size	Max allowed Tire Width	Max allowed Tire O.D.	Travel (mm)	Damper	Spring	Offset (mm)	Mat.	DIA (mm)	Mat.	Finish	Size Material	O.L.D.	Axle	Mat.	Max rotor DIA	Brake mount	
SF19	XCM32 LOR DS 15AH2 29"	no	3140	29"x2.4"	67mm	730mm	80 100 120	LOR	COIL w/ Preload adjuster	46	Al	32	STKM	Cr-plating	1-1/8"(TS), STKM, (OP) 1.5"to1-1/8" tapered(CTS), STKM	ø15-100	15AH2, (OP) 15QLC32	Al	180mm	Post 160 Direct	
SF19	XCM32 RL DS 15AH2 29"	no	3140	29"x2.4"	67mm	730mm	80 100 120	RL	COIL w/ Preload adjuster	46	Al	32	STKM	Cr-plating	1-1/8"(TS), STKM, (OP) 1.5"to1-1/8" tapered(CTS), STKM	ø15-100	15AH2, (OP) 15QLC32	Al	180mm	Post 160 Direct	
SF19	XCM32 LO DS 15AH2 29"	no	3140	29"x2.4"	63mm	758mm	80 100 120	LO	COIL w/ Preload adjuster	46	Al	32	STKM	Cr-plating	1-1/8"(TS), STKM, (OP) 1.5"to1-1/8" tapered(CTS), STKM	ø15-100	15AH2, (OP) 15QLC32	Al	180mm	Post 160 Direct	
SF19	XCM32 NLO DS 15AH2 29"	no	3140	29"x2.4"	63mm	758mm	80 100 120	NLO	COIL w/ Preload adjuster	46	Al	32	STKM	Cr-plating	1-1/8"(TS), STKM, (OP) 1.5"to1-1/8" tapered(CTS), STKM	ø15-100	15AH2, (OP) 15QLC32	Al	180mm	Post 160 Direct	
SF19	XCM32 DS 15AH2 29"	no	3140	29"x2.4"	63mm	758mm	80 100 120	-	COIL w/ Preload adjuster	46	Al	32	STKM	Cr-plating	1-1/8"(TS), STKM, (OP) 1.5"to1-1/8" tapered(CTS), STKM	ø15-100	15AH2, (OP) 15QLC32	Al	180mm	Post 160 Direct	
SF19	XCM32 LOR DS 15AH2 27.5"	no	3100	27.5"x2.25"	58mm	714mm	80 100 120	LOR	COIL w/ Preload adjuster	42	Al	32	STKM	Cr-plating	1-1/8"(TS), STKM, (OP) 1.5"to1-1/8" tapered(CTS), STKM	ø15-100	15AH2, (OP) 15QLC32	Al	180mm	Post 160 Direct	
SF19	XCM32 RL DS 15AH2 27.5"	no	3100	27.5"x2.25"	58mm	714mm	80 100 120	RL	COIL w/ Preload adjuster	42	Al	32	STKM	Cr-plating	1-1/8"(TS), STKM, (OP) 1.5"to1-1/8" tapered(CTS), STKM	ø15-100	15AH2, (OP) 15QLC32	Al	180mm	Post 160 Direct	
SF19	XCM32 LO DS 15AH2 27.5"	no	3100	27.5"x2.25"	58mm	714mm	80 100 120	LO	COIL w/ Preload adjuster	42	Al	32	STKM	Cr-plating	1-1/8"(TS), STKM, (OP) 1.5"to1-1/8" tapered(CTS), STKM	ø15-100	15AH2, (OP) 15QLC32	Al	180mm	Post 160 Direct	
SF19	XCM32 NLO DS 15AH2 27.5"	no	3100	27.5"x2.25"	58mm	714mm	80 100 120	NLO	COIL w/ Preload adjuster	42	Al	32	STKM	Cr-plating	1-1/8"(TS), STKM, (OP) 1.5"to1-1/8" tapered(CTS), STKM	ø15-100	15AH2, (OP) 15QLC32	Al	180mm	Post 160 Direct	
SF19	XCM32 DS 15AH2 27.5"	no	3100	27.5"x2.25"	58mm	714mm	80 100 120	-	COIL w/ Preload adjuster	42	Al	32	STKM	Cr-plating	1-1/8"(TS), STKM, (OP) 1.5"to1-1/8" tapered(CTS), STKM	ø15-100	15AH2, (OP) 15QLC32	Al	180mm	Post 160 Direct	

24"+

JR HLO 20"



MODEL YEAR	MODEL NAME	MAIN SPECIFICATIONS										CROWN		STANCHION		STEERER TUBE	AXLE		BOTTOM CASE / BRAKE		
		E-Bike ready	Weight (g) w/o axle	Wheel / Max. suggested tire size	Max allowed Tire Width	Max allowed Tire O.D.	Travel (mm)	Damper	Spring	Offset (mm)	Mat.	DIA (mm)	Mat.	Finish	Size Material	O.L.D.	Axle	Mat.	Max rotor DIA	Brake mount	
SF23	XCM32 RL DS 29"	no	-	29"x2.4"	63mm	758mm	80 100 120	RL	COIL w/ Preload adjuster	46	Al	32	STKM	Cr-plating	1-1/8"(TS), STKM, (OP) 1.5"to1-1/8" tapered(CTS), STKM	9-100	9mm-Dropout	Al	180mm	Post 160 Direct	
SF23	XCM32 LO DS 29"	no	-	29"x2.4"	63mm	758mm	80 100 120	LO	COIL w/ Preload adjuster	46	Al	32	STKM	Cr-plating	1-1/8"(TS), STKM, (OP) 1.5"to1-1/8" tapered(CTS), STKM	9-100	9mm-Dropout	Al	180mm	Post 160 Direct	
SF23	XCM32 NLO DS 29"	no	-	29"x2.4"	63mm	758mm	80 100 120	NLO	COIL w/ Preload adjuster	46	Al	32	STKM	Cr-plating	1-1/8"(TS), STKM, (OP) 1.5"to1-1/8" tapered(CTS), STKM	9-100	9mm-Dropout	Al	180mm	Post 160 Direct	
SF23	XCM32 DS 29"	no	-	29"x2.4"	63mm	758mm	80 100 120	-	COIL w/ Preload adjuster	46	Al	32	STKM	Cr-plating	1-1/8"(TS), STKM, (OP) 1.5"to1-1/8" tapered(CTS), STKM	9-100	9mm-Dropout	Al	180mm	Post 160 Direct	
SF23	XCM32 RL DS 27.5"	no	-	27.5"x2.25"	58mm	714mm	80 100 120	RL	COIL w/ Preload adjuster	42	Al	32	STKM	Cr-plating	1-1/8"(TS), STKM, (OP) 1.5"to1-1/8" tapered(CTS), STKM	9-100	9mm-Dropout	Al	180mm	Post 160 Direct	
SF23	XCM32 LO DS 27.5"	no	-	27.5"x2.25"	58mm	714mm	80 100 120	LO	COIL w/ Preload adjuster	42	Al	32	STKM	Cr-plating	1-1/8"(TS), STKM, (OP) 1.5"to1-1/8" tapered(CTS), STKM	9-100	9mm-Dropout	Al	180mm	Post 160 Direct	
SF23	XCM32 NLO DS 27.5"	no	-	27.5"x2.25"	58mm	714mm	80 100 120	NLO	COIL w/ Preload adjuster	42	Al	32	STKM	Cr-plating	1-1/8"(TS), STKM, (OP) 1.5"to1-1/8" tapered(CTS), STKM	9-100	9mm-Dropout	Al	180mm	Post 160 Direct	
SF23	XCM32 DS 27.5"	no	-	27.5"x2.25"	58mm	714mm	80 100 120	-	COIL w/ Preload adjuster	42	Al	32	STKM	Cr-plating	1-1/8"(TS), STKM, (OP) 1.5"to1-1/8" tapered(CTS), STKM	9-100	9mm-Dropout	Al	180mm	Post 160 Direct	
SF17	XCM30-Boost DS 15QLC32-110 24"+	no	2800	24"x2.8"	58mm	714mm	80	-	COIL w/ Preload adjuster	40	Al	30	STKM	Cr-plating	1-1/8"(TS), STKM	ø15-110	15QLC32-110	Al	180mm	Post 160 Direct	
SF18	XCM-JR AIR SL HLO DS 20"	no	-	20"x2.1"	58mm	714mm	80	HLO	AIR	40	Al	28	Alloy	Hard anodized, Black	1-1/8"(TS), Alloy	9-100	9mm-Dropout	Al	160mm	Post 160 Direct	



GLOSS BLACK



MATT BLACK



GLOSS WHITE

MAIN SPECIFICATIONS										CROWN		STANCHION		STEERER TUBE	AXLE		BOTTOM CASE / BRAKE			
MODEL YEAR	MODEL NAME	E-Bike ready	Weight (g) w/o axle	Wheel / Max. suggested tire size	Max allowed Tire Width	Max allowed Tire O.D.	Travel (mm)	Damper	Spring	Offset (mm)	Mat.	DIA (mm)	Mat.	Finish	Size Material	O.L.D.	Axle	Mat.	Max rotor DIA	Brake mount
SF21	XCM32-ATB RL DS 29"	no	-	29"x2.4"	64mm	718mm	80 100 120	RL	COIL w/ Preload adjuster	44	Al	32	STKM	Cr-plating	1.5"to1-1/8" tapered(CTS), STKM	9-100	9mm-Dropout	Al	180mm	Post 160 Direct
SF21	XCM32-ATB LO DS 29"	no	-	29"x2.4"	64mm	718mm	80 100 120	LO	COIL w/ Preload adjuster	44	Al	32	STKM	Cr-plating	1.5"to1-1/8" tapered(CTS), STKM	9-100	9mm-Dropout	Al	180mm	Post 160 Direct
SF21	XCM32-ATB NLO DS 29"	no	-	29"x2.4"	64mm	758mm	80 100 120	NLO	COIL w/ Preload adjuster	44	Al	32	STKM	Cr-plating	1.5"to1-1/8" tapered(CTS), STKM	9-100	9mm-Dropout	Al	180mm	Post 160 Direct
SF21	XCM32-ATB DS 29"	no	-	29"x2.4"	64mm	758mm	80 100 120	-	COIL w/ Preload adjuster	44	Al	32	STKM	Cr-plating	1.5"to1-1/8" tapered(CTS), STKM	9-100	9mm-Dropout	Al	180mm	Post 160 Direct
SF21	XCM32-ATB RL DS 27.5"	no	-	27.5"x2.4"	64mm	758mm	80 100 120	RL	COIL w/ Preload adjuster	44	Al	32	STKM	Cr-plating	1.5"to1-1/8" tapered(CTS), STKM	9-100	9mm-Dropout	Al	180mm	Post 160 Direct
SF21	XCM32-ATB LO DS 27.5"	no	-	27.5"x2.4"	64mm	758mm	80 100 120	LO	COIL w/ Preload adjuster	44	Al	32	STKM	Cr-plating	1.5"to1-1/8" tapered(CTS), STKM	9-100	9mm-Dropout	Al	180mm	Post 160 Direct
SF21	XCM32-ATB NLO DS 27.5"	no	-	27.5"x2.4"	64mm	718mm	80 100 120	NLO	COIL w/ Preload adjuster	44	Al	32	STKM	Cr-plating	1.5"to1-1/8" tapered(CTS), STKM	9-100	9mm-Dropout	Al	180mm	Post 160 Direct
SF21	XCM32-ATB DS 27.5"	no	-	27.5"x2.4"	64mm	718mm	80 100 120	-	COIL w/ Preload adjuster	44	Al	32	STKM	Cr-plating	1.5"to1-1/8" tapered(CTS), STKM	9-100	9mm-Dropout	Al	180mm	Post 160 Direct

30 HLO 29"



MODEL YEAR	MODEL NAME	MAIN SPECIFICATIONS										CROWN		STANCHION			STEERER TUBE		AXLE		BOTTOM CASE / BRAKE		
		E-Bike ready	Weight (g) w/o axle	Wheel / Max. suggested tire size	Max allowed Tire Width	Max allowed Tire O.D.	Travel (mm)	Damper	Spring	Offset (mm)	Mat.	DIA (mm)	Mat.	Finish	Size	Material	O.L.D.	Axle	Mat.	Max rotor DIA	Brake mount		
SF19	XCT30 HLO DS 29"	no	-	29"x2.25"	58mm	714mm	80 100	HLO	COIL w/ Preload adjuster	46	Al	30	STKM	Cr-plating	1-1/8"(TS), STKM	9-100	9mm-Dropout	Al	180mm	Post 160 Direct			
SF19	XCT30 DS 29"	no	-	29"x2.25"	58mm	714mm	80 100	-	COIL w/ Preload adjuster	46	Al	30	STKM	Cr-plating	1-1/8"(TS), STKM	9-100	9mm-Dropout	Al	180mm	Post 160 Direct			
SF19	XCT30 HLO DS 27.5"	no	-	27.5"x2.25"	73mm	678mm	80 100	HLO	COIL w/ Preload adjuster	42	Al	30	STKM	Cr-plating	1-1/8"(TS), STKM	9-100	9mm-Dropout	Al	180mm	Post 160 Direct			
SF19	XCT30 DS 27.5"	no	-	27.5"x2.25"	56mm	526mm	80 100	-	COIL w/ Preload adjuster	42	Al	30	STKM	Cr-plating	1-1/8"(TS), STKM	9-100	9mm-Dropout	Al	180mm	Post 160 Direct			

JR-L 24"

JR 20"



MODEL YEAR	MODEL NAME	MAIN SPECIFICATIONS										CROWN			STANCHION		STEERER TUBE		AXLE		BOTTOM CASE / BRAKE		
		E-Bike ready	Weight (g) w/o axle	Wheel / Max. suggested tire size	Max allowed Tire Width	Max allowed Tire O.D.	Travel (mm)	Damper	Spring	Offset (mm)	Mat.	DIA (mm)	Mat.	Finish	Size Material	O.L.D.	Axle	Mat.	Max rotor DIA	Brake mount			
SF19	XCT-Plus-E DS AIR NLO 24"	no	2250	24"x2.8"	73mm	655mm	70	NLO	AIR	40	Al	25,4	Al	Hard anodized, Black	1-1/8"(TS), Alloy	9-110	9mm-Dropout	Al	180mm	Post 160 Direct			
SF19	XCT-Plus DS AIR NLO 24"	no	2500	24"x2.8"	73mm	655mm	70	NLO	AIR	40	Al	25,4	STKM	Cr-plating	1-1/8"(TS), STKM	9-110	9mm-Dropout	Al	180mm	Post 160 Direct			
SF16	XCT-JR-L HLO DS 24"	no	2320	24"x2.1"	54mm	628mm	80	HLO	COIL w/ Preload adjuster	40	Al	28	STKM	Cr-plating	1-1/8"(TS), STKM	9-100	9mm-Dropout	Al	180mm	Post 160 Direct			
SF16	XCT-JR-L DS 24"	no	2320	24"x2.1"	54mm	628mm	80	-	COIL w/ Preload adjuster	40	Al	28	STKM	Cr-plating	1-1/8"(TS), STKM	9-100	9mm-Dropout	Al	180mm	Post 160 Direct			
SF18	XCT-JR P+DS 24"	no	-	24"x2.1"	54mm	628mm	50	-	COIL w/ Preload adjuster	40	Al	25,4	STKM	Cr-plating	1-1/8"(TS), STKM	9-100	9mm-Dropout	Al	180mm	V-Brake +Post			
SF20	XCT-JR DS 24"	no	1985	24"x2.1"	54mm	628mm	50	-	COIL w/ Preload adjuster	40	Al	25,4	STKM	Cr-plating	1-1/8"(TS), STKM	9-100	9mm-Dropout	Al	180mm	Post 160 Direct			
SF12	XCT-JR P 24"	no	1985	24"x2.1"	54mm	628mm	50	-	COIL w/ Preload adjuster	40	Al	25,4	STKM	Cr-plating	1-1/8"(TS), STKM	9-100	9mm-Dropout	Al	180mm	V-Brake			
SF17	XCT DS 20" Plus	no	2120	20"x2.8"	58mm	750mm	60	-	COIL w/ Preload adjuster	40	Al	28	STKM	Cr-plating	1-1/8"(TS), STKM	9-110	9mm-Dropout	Al	180mm	Post 160 Direct			
SF16	XCT-JR-L DS 20"	no	2100	20"x2.1"	73mm	554mm	63	-	COIL w/ Preload adjuster	40	Al	28	STKM	Cr-plating	1-1/8"(TS), STKM	9-100	9mm-Dropout	Al	180mm	Post 160 Direct			
SF13	XCT-JR P 20"	no	1940	20"x2.1"	56mm	526mm	40	-	COIL w/ Preload adjuster	40	Al	25,4	STKM	Cr-plating	1-1/8"(TS), STKM	9-100	9mm-Dropout	Al	180mm	V-Brake +Post			



DS 29"

P 29"



MODEL YEAR	MODEL NAME	MAIN SPECIFICATIONS										CROWN			STANCHION		STEERER TUBE		AXLE		BOTTOM CASE / BRAKE		
		E-Bike ready	Weight (g) w/o axle	Wheel / Max. suggested tire size	Max allowed Tire Width	Max allowed Tire O.D.	Travel (mm)	Damper	Spring	Offset (mm)	Mat.	DIA (mm)	Mat.	Finish	Size	Material	O.L.D.	Axle	Mat.	Max rotor DIA	Brake mount		
SF18	XCE28 DS 29"	no	2660	29"x2.25"	58mm	750mm	80 / 100	-	COIL w/ Preload adjuster	46	Al	28	STKM	Cr-plating	1-1/8"(TS), STKM	9-100	9mm-Dropout	Al	180mm	Post 160 Direct			
SF18	XCE28 P 29"	no	2660	29"x2.25"	58mm	750mm	80 / 100	-	COIL w/ Preload adjuster	46	Al	28	STKM	Cr-plating	1-1/8"(TS), STKM	9-100	9mm-Dropout	Al	-	V-Brake			
SF18	XCE28 DS 27.5"	no	2630	27.5"x2.25"	58mm	714mm	80 / 100	-	COIL w/ Preload adjuster	42	Al	28	STKM	Cr-plating	1-1/8"(TS), STKM	9-100	9mm-Dropout	Al	180mm	Post 160 Direct			
SF18	XCE28 P 27.5"	no	2630	27.5"x2.25"	58mm	714mm	80 / 100	-	COIL w/ Preload adjuster	42	Al	28	STKM	Cr-plating	1-1/8"(TS), STKM	9-100	9mm-Dropout	Al	-	V-Brake			
SF18	XCE28 DS 26"	no	2600	26"x2.1"	54mm	680mm	80 / 100	-	COIL w/ Preload adjuster	40	Al	28	STKM	Cr-plating	1-1/8"(TS), STKM	9-100	9mm-Dropout	Al	180mm	Post 160 Direct			
SF18	XCE28 P 26"	no	2600	26"x2.1"	54mm	680mm	80 / 100	-	COIL w/ Preload adjuster	40	Al	28	STKM	Cr-plating	1-1/8"(TS), STKM	9-100	9mm-Dropout	Al	-	V-Brake			

# M3010

CASUAL MTB

700<sup>C</sup>

26"

24"

20"

25.4 mm

P 700C

P 24"



CASUAL MTB

M3010

MODEL YEAR	MODEL NAME	MAIN SPECIFICATIONS										CROWN			STANCHION			STEERER TUBE		AXLE		BOTTOM CASE / BRAKE		
		E-Bike ready	Weight (g) w/o axle	Wheel / Max. suggested tire size	Max allowed Tire Width	Max allowed Tire O.D.	Travel (mm)	Damper	Spring	Offset (mm)	Mat.	DIA (mm)	Mat.	Finish	Size	Material	O.L.D.	Axle	Mat.	Max rotor DIA	Brake mount			
SF14	M3010-A P 700C	no	2269	700Cx52C	58mm	714mm	40 50 63	-	COIL w/ Preload adjuster	42	Al	25,4	STKM	Cr-plating	1-1/8"(TS), STKM	9-100	9mm-Dropout	Al	-	V-Brake				
SF14	M3010 P 700C	no	2250	700Cx52C	58mm	714mm	40 50 63	-	COIL	42	Al	25,4	STKM	Cr-plating	1-1/8"(TS), STKM	9-100	9mm-Dropout	Al	-	V-Brake				
SF15	M3010-A P 26"	no	2260	26"x2.1"	54mm	680mm	50 63	-	COIL w/ Preload adjuster	42	Al	25,4	STKM	Cr-plating	1-1/8"(TS), STKM	9-100	9mm-Dropout	Al	-	V-Brake				
SF15	M3010 P 26"	no	2240	26"x2.1"	54mm	680mm	50 63	-	COIL	42	Al	25,4	STKM	Cr-plating	1-1/8"(TS), STKM	9-100	9mm-Dropout	Al	-	V-Brake				
SF15	M3010-A P 24"	no	2180	24"x2.1"	54mm	742mm	50	-	COIL w/ Preload adjuster	42	Al	25,4	STKM	Cr-plating	1-1/8"(TS), STKM	9-100	9mm-Dropout	Al	-	V-Brake				
SF15	M3010 P 24"	no	2160	24"x2.1"	54mm	742mm	50	-	COIL	42	Al	25,4	STKM	Cr-plating	1-1/8"(TS), STKM	9-100	9mm-Dropout	Al	-	V-Brake				
SF14	M3010-A P 20"	no	1915	20"x2.1"	54mm	684mm	40	-	COIL w/ Preload adjuster	42	Al	25,4	STKM	Cr-plating	1-1/8"(TS), STKM	9-100	9mm-Dropout	Al	-	V-Brake				
SF14	M3010 P 20"	no	1897	20"x2.1"	54mm	684mm	40	-	COIL	42	Al	25,4	STKM	Cr-plating	1-1/8"(TS), STKM	9-100	9mm-Dropout	Al	-	V-Brake				

SPECIFICATIONS

// 21025

SUNTOUR

# MOBIE36

URBAN / SPORTS UTILITY

29"

27.5"

36mm

36 Boost ABS EQ  
3CR-PCS 29"



GLOSS BLACK



MATT BLACK



GLOSS WHITE

URBAN / SPORTS UTILITY

MOBIE36

MODEL YEAR	MODEL NAME	MAIN SPECIFICATIONS								CROWN			STANCHION			STEERER TUBE		AXLE		BOTTOM CASE / BRAKE		
		E-Bike ready	Weight (g) w/o axle	Wheel / Max. suggested tire size	Max allowed Tire Width	Max allowed Tire O.D.	Travel (mm)	Damper	Spring	Offset (mm)	Mat.	DIA (mm)	Mat.	Finish	Size	Material	O.L.D.	Axle	Mat.	Max rotor DIA	Brake mount	Note
SF25	MOBIE36-Boost EQ ABS 3CR-PCS DS 15AH2-110 29"	yes	-	29"x2.6"	67mm	756mm	120 130 140 150	3CR-PCS	AIR (EQ)	51	Al	36	Al	Hard anodized, Black	1.5"to1-1/8" tapered(CTS), Alloy, (OP) 1.8"to1-1/8" tapered(CTS), Alloy	ø15-110	15AH2-110, (OP) 15LH-110	Mg	220mm	Post 180 Direct	with lamp mount*	
SF25	MOBIE36-Boost EQ 3CR-PCS DS 15AH2-110 29"	yes	-	29"x2.6"	67mm	756mm	120 130 140 150	3CR-PCS	AIR (EQ)	51	Al	36	Al	Hard anodized, Black	1.5"to1-1/8" tapered(CTS), Alloy, (OP) 1.8"to1-1/8" tapered(CTS), Alloy	ø15-110	15AH2-110, (OP) 15LH-110	Mg	220mm	Post 180 Direct	with lamp mount*	
SF25	MOBIE36-Boost EQ ABS LORC-PCS DS 15AH2-110 29"	yes	-	29"x2.6"	67mm	756mm	120 130 140 150	LORC-PCS	AIR (EQ)	51	Al	36	Al	Hard anodized, Black	1.5"to1-1/8" tapered(CTS), Alloy, (OP) 1.8"to1-1/8" tapered(CTS), Alloy	ø15-110	15AH2-110, (OP) 15LH-110	Mg	220mm	Post 180 Direct	with lamp mount*	
SF25	MOBIE36-Boost EQ LORC-PCS DS 15AH2-110 29"	yes	-	29"x2.6"	67mm	756mm	120 130 140 150	LORC-PCS	AIR (EQ)	51	Al	36	Al	Hard anodized, Black	1.5"to1-1/8" tapered(CTS), Alloy, (OP) 1.8"to1-1/8" tapered(CTS), Alloy	ø15-110	15AH2-110, (OP) 15LH-110	Mg	220mm	Post 180 Direct	with lamp mount*	
SF25	MOBIE36-Boost EQ ABS 2CR-PCS DS 15AH2-110 29"	yes	-	29"x2.6"	67mm	756mm	120 130 140 150	2CR-PCS	AIR (EQ)	51	Al	36	Al	Hard anodized, Black	1.5"to1-1/8" tapered(CTS), Alloy, (OP) 1.8"to1-1/8" tapered(CTS), Alloy	ø15-110	15AH2-110, (OP) 15LH-110	Mg	220mm	Post 180 Direct	with lamp mount*	
SF25	MOBIE36-Boost EQ 2CR-PCS DS 15AH2-110 29"	yes	-	29"x2.6"	67mm	756mm	120 130 140 150	2CR-PCS	AIR (EQ)	51	Al	36	Al	Hard anodized, Black	1.5"to1-1/8" tapered(CTS), Alloy, (OP) 1.8"to1-1/8" tapered(CTS), Alloy	ø15-110	15AH2-110, (OP) 15LH-110	Mg	220mm	Post 180 Direct	with lamp mount*	

\*Front face on fork crown

SPECIFICATIONS

// 21/25

SF25

# MOBIE36

URBAN / SPORTS UTILITY

29"

27.5"

36mm

36 Boost ABS EQ  
3CR-PCS 29"



GLOSS BLACK



MATT BLACK



GLOSS WHITE

URBAN / SPORTS UTILITY

MOBIE36

MODEL YEAR	MODEL NAME	MAIN SPECIFICATIONS										CROWN			STANCHION			STEERER TUBE		AXLE		BOTTOM CASE / BRAKE		
		E-Bike ready	Weight (g) w/o axle	Wheel / Max. suggested tire size	Max allowed Tire Width	Max allowed Tire O.D.	Travel (mm)	Damper	Spring	Offset (mm)	Mat.	DIA (mm)	Mat.	Finish	Size	Material	O.L.D.	Axle	Mat.	Max rotor DIA	Brake mount	Note		
SF25	MOBIE36-Boost EQ ABS 3CR-PCS DS 15AH2-110 27.5"	yes	-	27.5"x2.6"	67mm	723mm	120 130 140 150	3CR-PCS	AIR (EQ)	44	Al	36	Al	Hard anodized, Black	1.5"to1-1/8" tapered(CTS), Alloy, (OP) 1.8"to1-1/8" tapered(CTS), Alloy	ø15-110	15AH2-110, (OP) 15LH-110	Mg	220mm	Post 180 Direct	with lamp mount*			
SF25	MOBIE36-Boost EQ 3CR-PCS DS 15AH2-110 27.5"	yes	-	27.5"x2.6"	67mm	723mm	120 130 140 150	3CR-PCS	AIR (EQ)	44	Al	36	Al	Hard anodized, Black	1.5"to1-1/8" tapered(CTS), Alloy, (OP) 1.8"to1-1/8" tapered(CTS), Alloy	ø15-110	15AH2-110, (OP) 15LH-110	Mg	220mm	Post 180 Direct	with lamp mount*			
SF25	MOBIE36-Boost EQ ABS LORC-PCS DS 15AH2-110 27.5"	yes	-	27.5"x2.6"	67mm	723mm	120 130 140 150	LORC-PCS	AIR (EQ)	44	Al	36	Al	Hard anodized, Black	1.5"to1-1/8" tapered(CTS), Alloy, (OP) 1.8"to1-1/8" tapered(CTS), Alloy	ø15-110	15AH2-110, (OP) 15LH-110	Mg	220mm	Post 180 Direct	with lamp mount*			
SF25	MOBIE36-Boost EQ LORC-PCS DS 15AH2-110 27.5"	yes	-	27.5"x2.6"	67mm	723mm	120 130 140 150	LORC-PCS	AIR (EQ)	44	Al	36	Al	Hard anodized, Black	1.5"to1-1/8" tapered(CTS), Alloy, (OP) 1.8"to1-1/8" tapered(CTS), Alloy	ø15-110	15AH2-110, (OP) 15LH-110	Mg	220mm	Post 180 Direct	with lamp mount*			
SF25	MOBIE36-Boost EQ ABS 2CR-PCS DS 15AH2-110 27.5"	yes	-	27.5"x2.6"	67mm	723mm	120 130 140 150	2CR-PCS	AIR (EQ)	44	Al	36	Al	Hard anodized, Black	1.5"to1-1/8" tapered(CTS), Alloy, (OP) 1.8"to1-1/8" tapered(CTS), Alloy	ø15-110	15AH2-110, (OP) 15LH-110	Mg	220mm	Post 180 Direct	with lamp mount*			
SF25	MOBIE36-Boost EQ 2CR-PCS DS 15AH2-110 27.5"	yes	-	27.5"x2.6"	67mm	723mm	120 130 140 150	2CR-PCS	AIR (EQ)	44	Al	36	Al	Hard anodized, Black	1.5"to1-1/8" tapered(CTS), Alloy, (OP) 1.8"to1-1/8" tapered(CTS), Alloy	ø15-110	15AH2-110, (OP) 15LH-110	Mg	220mm	Post 180 Direct	with lamp mount*			

\*Front face on fork crown

SPECIFICATIONS

// 2125

SUNTOUR

# MOBIE34

URBAN / UTILITY

29"

700<sup>c</sup>

27.5"

34mm

34 Boost EQ  
ABS 3CR 29"



GLOSS BLACK



MATT BLACK



GLOSS WHITE

URBAN / UTILITY

MOBIE34

## MAIN SPECIFICATIONS

MODEL YEAR	MODEL NAME	MAIN SPECIFICATIONS										CROWN			STANCHION			STEERER TUBE		AXLE		BOTTOM CASE / BRAKE		
		E-Bike ready	Weight (g) w/o axle	Wheel / Max. suggested tire size	Max allowed Tire Width	Max allowed Tire O.D.	Travel (mm)	Damper	Spring	Offset (mm)	Mat.	DIA (mm)	Mat.	Finish	Size	Material	O.L.D.	Axle	Mat.	Max rotor DIA	Brake mount	Note		
SF24	MOBIE34-Boost EQ ABS 2CR DS 15AH2-110 29"	yes	-	29"x2.4"	63mm	754mm	80 100 120	2CR	AIR (EQ)	51	Al	34	Al	Hard anodized, Black	1.5"to1-1/8" tapered(CTS), Alloy, (OP) 1.8"to1-1/8" tapered(CTS), Alloy	ø15-110	15AH2-110	Mg	203mm	Post 180 Direct	with lamp mount*			
SF24	MOBIE34-Boost EQ 2CR DS 15AH2-110 29"	yes	-	29"x2.4"	63mm	754mm	80 100 120	2CR	AIR (EQ)	51	Al	34	Al	Hard anodized, Black	1.5"to1-1/8" tapered(CTS), Alloy, (OP) 1.8"to1-1/8" tapered(CTS), Alloy	ø15-110	15AH2-110	Mg	203mm	Post 180 Direct	with lamp mount*			
SF24	MOBIE34-D-Boost AIR ABS 2CR DS 15AH2-110 29"	yes	-	29"x2.4"	63mm	754mm	80 100 120	2CR	AIR	51	Al	34	STKM	Black	1.5"to1-1/8" tapered(CTS), Alloy, (OP) 1.8"to1-1/8" tapered(CTS), Alloy	ø15-110	15AH2-110	Mg	203mm	Post 180 Direct	with lamp mount*			
SF24	MOBIE34-D-Boost AIR 2CR DS 15AH2-110 29"	yes	-	29"x2.4"	63mm	754mm	80 100 120	2CR	AIR	51	Al	34	STKM	Black	1.5"to1-1/8" tapered(CTS), Alloy, (OP) 1.8"to1-1/8" tapered(CTS), Alloy	ø15-110	15AH2-110	Mg	203mm	Post 180 Direct	with lamp mount*			
SF24	MOBIE34-Boost EQ ABS 2CR DS 15AH2-110 27.5"	yes	-	27.5"x2.6"	67mm	723mm	80 100 120	2CR	AIR (EQ)	44	Al	34	Al	Hard anodized, Black	1.5"to1-1/8" tapered(CTS), Alloy, (OP) 1.8"to1-1/8" tapered(CTS), Alloy	ø15-110	15AH2-110	Mg	203mm	Post 180 Direct	with lamp mount*			
SF24	MOBIE34-Boost EQ 2CR DS 15AH2-110 27.5"	yes	-	27.5"x2.6"	67mm	723mm	80 100 120	2CR	AIR (EQ)	44	Al	34	Al	Hard anodized, Black	1.5"to1-1/8" tapered(CTS), Alloy, (OP) 1.8"to1-1/8" tapered(CTS), Alloy	ø15-110	15AH2-110	Mg	203mm	Post 180 Direct	with lamp mount*			
SF24	MOBIE34-D-Boost AIR ABS 2CR DS 15AH2-110 27.5"	yes	-	27.5"x2.6"	67mm	723mm	80 100 120	2CR	AIR	44	Al	34	STKM	Black	1.5"to1-1/8" tapered(CTS), Alloy, (OP) 1.8"to1-1/8" tapered(CTS), Alloy	ø15-110	15AH2-110	Mg	203mm	Post 180 Direct	with lamp mount*			
SF24	MOBIE34-D-Boost AIR 2CR DS 15AH2-110 27.5"	yes	-	27.5"x2.6"	67mm	723mm	80 100 120	2CR	AIR	44	Al	34	STKM	Black	1.5"to1-1/8" tapered(CTS), Alloy, (OP) 1.8"to1-1/8" tapered(CTS), Alloy	ø15-110	15AH2-110	Mg	203mm	Post 180 Direct	with lamp mount*			

\*Front face on fork crown

SPECIFICATIONS

// 2K25

SFSAUNOR

# MOBIE34

URBAN / UTILITY

29"

700<sup>C</sup>

27.5"

34mm

34-D Boost ABS 2CR 29"



GLOSS BLACK



MATT BLACK



GLOSS WHITE

URBAN / UTILITY

MOBIE34

MODEL YEAR	MODEL NAME	MAIN SPECIFICATIONS										CROWN			STANCHION			STEERER TUBE		AXLE		BOTTOM CASE / BRAKE		
		E-Bike ready	Weight (g) w/o axle	Wheel / Max. suggested tire size	Max allowed Tire Width	Max allowed Tire O.D.	Travel (mm)	Damper	Spring	Offset (mm)	Mat.	DIA (mm)	Mat.	Finish	Size Material	O.L.D.	Axle	Mat.	Max rotor DIA	Brake mount	Note			
SF25	MOBIE34 EQ ABS R-2CR DS 15AH2 700C	yes	-	700Cx57C	59mm	751mm	80/100	R-2CR	AIR (EQ)	44	Al	34	Al	Hard anodized, Black	1.5"to1-1/8" tapered(CTS), Alloy	ø15-100	15AH2	Mg	203mm	Post 180 Direct	with lamp mount*			
SF25	MOBIE34 EQ ABS 2CR DS 15AH2 700C	yes	-	700Cx57C	59mm	751mm	80/100	2CR	AIR (EQ)	44	Al	34	Al	Hard anodized, Black	1.5"to1-1/8" tapered(CTS), Alloy	ø15-100	15AH2	Mg	203mm	Post 180 Direct	with lamp mount*			
SF25	MOBIE34 EQ R-2CR DS 15AH2 700C	yes	-	700Cx57C	59mm	751mm	80/100	R-2CR	AIR (EQ)	44	Al	34	Al	Hard anodized, Black	1.5"to1-1/8" tapered(CTS), Alloy	ø15-100	15AH2	Mg	203mm	Post 180 Direct	with lamp mount*			
SF25	MOBIE34 EQ 2CR DS 15AH2 700C	yes	-	700Cx57C	59mm	751mm	80/100	2CR	AIR (EQ)	44	Al	34	Al	Hard anodized, Black	1.5"to1-1/8" tapered(CTS), Alloy	ø15-100	15AH2	Mg	203mm	Post 180 Direct	with lamp mount*			
SF25	MOBIE34-D AIR ABS R-2CR DS 15AH2 700C	yes	-	700Cx57C	59mm	751mm	80/100	R-2CR	AIR	44	Al	34	STKM	Black	1.5"to1-1/8" tapered(CTS), Alloy	ø15-100	15AH2	Mg	203mm	Post 180 Direct	with lamp mount*			
SF25	MOBIE34-D AIR ABS 2CR DS 15AH2 700C	yes	-	700Cx57C	59mm	751mm	80/100	2CR	AIR	44	Al	34	STKM	Black	1.5"to1-1/8" tapered(CTS), Alloy	ø15-100	15AH2	Mg	203mm	Post 180 Direct	with lamp mount*			
SF25	MOBIE34-D AIR R-2CR DS 15AH2 700C	yes	-	700Cx57C	59mm	751mm	80/100	R-2CR	AIR	44	Al	34	STKM	Black	1.5"to1-1/8" tapered(CTS), Alloy	ø15-100	15AH2	Mg	203mm	Post 180 Direct	with lamp mount*			
SF25	MOBIE34-D AIR 2CR DS 15AH2 700C	yes	-	700Cx57C	59mm	751mm	80/100	2CR	AIR	44	Al	34	STKM	Black	1.5"to1-1/8" tapered(CTS), Alloy	ø15-100	15AH2	Mg	203mm	Post 180 Direct	with lamp mount*			

\*Front face on fork crown

SPECIFICATIONS

// 21/25

SF25

# MOBIE 34

URBAN / UTILITY

29"

700<sup>c</sup>

27.5"

34mm

34-D Boost ABS 2CR 29"



GLOSS BLACK

MATT BLACK

GLOSS WHITE

URBAN / UTILITY

MOBIE34

MODEL YEAR	MODEL NAME	MAIN SPECIFICATIONS										CROWN		STANCHION		STEERER TUBE		AXLE		BOTTOM CASE / BRAKE		Note
		E-Bike ready	Weight (g) w/o axle	Wheel / Max. suggested tire size	Max allowed Tire Width	Max allowed Tire O.D.	Travel (mm)	Damper	Spring	Offset (mm)	Mat.	DIA (mm)	Mat.	Finish	Size Material	O.L.D.	Axle	Mat.	Max rotor DIA	Brake mount		
SF25	MOBIE34 EQ ABS R-2CR DS 15AH2 27.5"	yes	-	27.5"x2.4"	63mm	717mm	80 100	R-2CR	AIR (EQ)	44	Al	34	Al	Hard anodized, Black	1.5"to1-1/8" tapered(CTS), Alloy	ø15-100	15AH2	Mg	203mm	Post 180 Direct	with lamp mount*	
SF25	MOBIE34 EQ ABS 2CR DS 15AH2 27.5"	yes	-	27.5"x2.4"	63mm	717mm	80 100	2CR	AIR (EQ)	44	Al	34	Al	Hard anodized, Black	1.5"to1-1/8" tapered(CTS), Alloy	ø15-100	15AH2	Mg	203mm	Post 180 Direct	with lamp mount*	
SF25	MOBIE34 EQ R-2CR DS 15AH2 27.5"	yes	-	27.5"x2.4"	63mm	717mm	80 100	R-2CR	AIR (EQ)	44	Al	34	Al	Hard anodized, Black	1.5"to1-1/8" tapered(CTS), Alloy	ø15-100	15AH2	Mg	203mm	Post 180 Direct	with lamp mount*	
SF25	MOBIE34 EQ 2CR DS 15AH2 27.5"	yes	-	27.5"x2.4"	63mm	717mm	80 100	2CR	AIR (EQ)	44	Al	34	Al	Hard anodized, Black	1.5"to1-1/8" tapered(CTS), Alloy	ø15-100	15AH2	Mg	203mm	Post 180 Direct	with lamp mount*	
SF25	MOBIE34-D AIR ABS R-2CR DS 15AH2 27.5"	yes	-	27.5"x2.4"	63mm	717mm	80 100	R-2CR	AIR	44	Al	34	STKM	Black	1.5"to1-1/8" tapered(CTS), Alloy	ø15-100	15AH2	Mg	203mm	Post 180 Direct	with lamp mount*	
SF25	MOBIE34-D AIR ABS 2CR DS 15AH2 27.5"	yes	-	27.5"x2.4"	63mm	717mm	80 100	2CR	AIR	44	Al	34	STKM	Black	1.5"to1-1/8" tapered(CTS), Alloy	ø15-100	15AH2	Mg	203mm	Post 180 Direct	with lamp mount*	
SF25	MOBIE34-D AIR R-2CR DS 15AH2 27.5"	yes	-	27.5"x2.4"	63mm	717mm	80 100	R-2CR	AIR	44	Al	34	STKM	Black	1.5"to1-1/8" tapered(CTS), Alloy	ø15-100	15AH2	Mg	203mm	Post 180 Direct	with lamp mount*	
SF25	MOBIE34-D AIR 2CR DS 15AH2 27.5"	yes	-	27.5"x2.4"	63mm	717mm	80 100	2CR	AIR	44	Al	34	STKM	Black	1.5"to1-1/8" tapered(CTS), Alloy	ø15-100	15AH2	Mg	203mm	Post 180 Direct	with lamp mount*	

\*Front face on fork crown

SPECIFICATIONS

// 21025

SF25MOBIE34

# MOBIE25

URBAN / UTILITY

700<sup>G</sup>

27.5<sup>"</sup>

32<sup>mm</sup>

AIR LOR 700C



GLOSS BLACK

MATT BLACK

GLOSS WHITE

URBAN / UTILITY

MOBIE25

MODEL YEAR	MODEL NAME	MAIN SPECIFICATIONS										CROWN		STANCHION		STEERER TUBE	AXLE		BOTTOM CASE / BRAKE		
		E-Bike ready	Weight (g) w/o axle	Wheel / Max. suggested tire size	Max allowed Tire Width	Max allowed Tire O.D.	Travel (mm)	Damper	Spring	Offset (mm)	Mat.	DIA (mm)	Mat.	Finish	Size Material	O.L.D.	Axle	Mat.	Max rotor DIA	Brake mount	Note
SF18	MOBIE25-AIR RLR DS 15QLC32 700C	yes	2120	700Cx57C	59mm	751mm	63 75 100	RLR	AIR	44	Al	32	Al	Hard anodized, Black	1.5"to1-1/8" tapered(CTS), Alloy	ø15-100	15QLC32	Mg	180mm	Post 160 Direct	with lamp mount*
SF18	MOBIE25-AIR LOR DS 15QLC32 700C	yes	2000	700Cx57C	59mm	751mm	63 75 100	LOR	AIR	44	Al	32	Al	Hard anodized, Black	1.5"to1-1/8" tapered(CTS), Alloy	ø15-100	15QLC32	Mg	180mm	Post 160 Direct	with lamp mount*
SF18	MOBIE25-COIL RLR DS 15QLC32 700C	yes	2210	700Cx57C	59mm	751mm	63 75 100	RLR	COIL w/ Preload adjuster	44	Al	32	Al	Hard anodized, Black	1.5"to1-1/8" tapered(CTS), Alloy	ø15-100	15QLC32	Mg	180mm	Post 160 Direct	with lamp mount*
SF18	MOBIE25-COIL LOR DS 15QLC32 700C	yes	2210	700Cx57C	59mm	751mm	63 75 100	LOR	COIL w/ Preload adjuster	44	Al	32	Al	Hard anodized, Black	1.5"to1-1/8" tapered(CTS), Alloy	ø15-100	15QLC32	Mg	180mm	Post 160 Direct	with lamp mount*
SF18	MOBIE25-AIR RLR DS 15QLC32 27.5"	yes	2006	27.5"x2.4"	63mm	717mm	63 75 100	RLR	AIR	44	Al	32	Al	Hard anodized, Black	1.5"to1-1/8" tapered(CTS), Alloy	ø15-100	15QLC32	Mg	180mm	Post 160 Direct	with lamp mount*
SF18	MOBIE25-AIR LOR DS 15QLC32 27.5"	yes	2000	27.5"x2.4"	63mm	717mm	63 75 100	LOR	AIR	44	Al	32	Al	Hard anodized, Black	1.5"to1-1/8" tapered(CTS), Alloy	ø15-100	15QLC32	Mg	180mm	Post 160 Direct	with lamp mount*
SF18	MOBIE25-COIL RLR DS 15QLC32 27.5"	yes	2210	27.5"x2.4"	63mm	717mm	63 75 100	RLR	COIL w/ Preload adjuster	44	Al	32	Al	Hard anodized, Black	1.5"to1-1/8" tapered(CTS), Alloy	ø15-100	15QLC32	Mg	180mm	Post 160 Direct	with lamp mount*
SF18	MOBIE25-COIL LOR DS 15QLC32 27.5"	yes	2210	27.5"x2.4"	63mm	717mm	63 75 100	LOR	COIL w/ Preload adjuster	44	Al	32	Al	Hard anodized, Black	1.5"to1-1/8" tapered(CTS), Alloy	ø15-100	15QLC32	Mg	180mm	Post 160 Direct	with lamp mount*

\*Front face on fork crown

SPECIFICATIONS

// 21C25

SJS JOUR



# MOBIE-A32

URBAN / UTILITY



LO 29"



CGO 20"



URBAN / UTILITY  
MOBIE-A32

		MAIN SPECIFICATIONS										CROWN			STANCHION		STEERER TUBE		AXLE		BOTTOM CASE / BRAKE		
MODEL YEAR	MODEL NAME	E-Bike ready	Weight (g) w/o axle	Wheel / Max. suggested tire size	Max allowed Tire Width	Max allowed Tire O.D.	Travel (mm)	Damper	Spring	Offset (mm)	Mat.	DIA (mm)	Mat.	Finish	Size Material	O.L.D.	Axle	Mat.	Max rotor DIA	Brake mount	Note		
SF21	MOBIE-A32 COIL RL DS 15AH2 29"	yes	2170	29"x2.4"	63mm	750mm	63 75	RL	COIL w/ Preload adjuster	44	Al	32	STKM	Cr-plating	1.5"to1-1/8" tapered(CTS), STKM	ø15-100	15AH2	Al	180mm	Post 160 Direct	with lamp mount*		
SF21	MOBIE-A32 COIL LO DS 15AH2 29"	yes	2170	29"x2.4"	63mm	750mm	63 75	LO	COIL w/ Preload adjuster	44	Al	32	STKM	Cr-plating	1.5"to1-1/8" tapered(CTS), STKM	ø15-100	15AH2	Al	180mm	Post 160 Direct	with lamp mount*		
SF21	MOBIE-A32 COIL NLO DS 15AH2 29"	yes	2170	29"x2.4"	63mm	750mm	63 75	NLO	COIL w/ Preload adjuster	44	Al	32	STKM	Cr-plating	1.5"to1-1/8" tapered(CTS), STKM	ø15-100	15AH2	Al	180mm	Post 160 Direct	with lamp mount*		
SF21	MOBIE-A32 COIL DS 15AH2 29"	yes	2160	29"x2.4"	63mm	750mm	63 75	-	COIL w/ Preload adjuster	44	Al	32	STKM	Cr-plating	1.5"to1-1/8" tapered(CTS), STKM	ø15-100	15AH2	Al	180mm	Post 160 Direct	with lamp mount*		
SF21	MOBIE-A32 COIL RL DS 15AH2 27.5"	yes	2170	27.5"x2.4"	63mm	717mm	63 75	RL	COIL w/ Preload adjuster	44	Al	32	STKM	Cr-plating	1.5"to1-1/8" tapered(CTS), STKM	ø15-100	15AH2	Al	180mm	Post 160 Direct	with lamp mount*		
SF21	MOBIE-A32 COIL LO DS 15AH2 27.5"	yes	2170	27.5"x2.4"	63mm	717mm	63 75	LO	COIL w/ Preload adjuster	44	Al	32	STKM	Cr-plating	1.5"to1-1/8" tapered(CTS), STKM	ø15-100	15AH2	Al	180mm	Post 160 Direct	with lamp mount*		
SF21	MOBIE-A32 COIL NLO DS 15AH2 27.5"	yes	2170	27.5"x2.4"	63mm	717mm	63 75	NLO	COIL w/ Preload adjuster	44	Al	32	STKM	Cr-plating	1.5"to1-1/8" tapered(CTS), STKM	ø15-100	15AH2	Al	180mm	Post 160 Direct	with lamp mount*		
SF21	MOBIE-A32 COIL DS 15AH2 27.5"	yes	2160	27.5"x2.4"	63mm	717mm	63 75	-	COIL w/ Preload adjuster	44	Al	32	STKM	Cr-plating	1.5"to1-1/8" tapered(CTS), STKM	ø15-100	15AH2	Al	180mm	Post 160 Direct	with lamp mount*		
SF22	MOBIE-A32 NLO DS 15AH2 20"	no	2700	20"x2.25"	64mm	718mm	50	NLO	COIL w/ Preload adjuster	38	Alloy	32	STKM reinforced	Cr-plating	1.5"to1-1/8" tapered(CTS), STKM	ø15-100	15AH2	Al	180mm	Post 160 Direct	-		
SF22	MOBIE-A32 DS 15AH2 20"	no	2700	20"x2.25"	64mm	718mm	50	-	COIL w/ Preload adjuster	38	Alloy	32	STKM reinforced	Cr-plating	1.5"to1-1/8" tapered(CTS), STKM	ø15-100	15AH2	Al	180mm	Post 160 Direct	-		

\*Front face on fork crown

SPECIFICATIONS

// 21025



# MOBIE34-CGO

URBAN / UTILITY

24"

20"

34mm



34 CGO Boost LO 20"



E-BIKE  
READY



A32 CGO 20"



E-BIKE  
READY



GLOSS BLACK

MATT BLACK

GLOSS WHITE

URBAN / UTILITY

MOBIE34-CGO

MODEL YEAR	MODEL NAME	MAIN SPECIFICATIONS										CROWN			STANCHION			STEERER TUBE		AXLE		BOTTOM CASE / BRAKE		
		E-Bike ready	Weight (g) w/o axle	Wheel / Max suggested tire size	Max allowed Tire Width	Max allowed Tire O.D.	Travel (mm)	Damper	Spring	Offset (mm)	Mat.	DIA (mm)	Mat.	Finish	Size Material	O.L.D.	Axle	Mat.	Max rotor DIA	Brake mount	Note			
SF23	MOBIE34-CGO Boost DS LO 15AH2-110 24"	yes	-	24"x2.6"	68mm	640mm	80 100	LO	COIL w/ Preload adjuster	44	Al	34	STKM	Black	1.5"to1-1/8" tapered(CTS), reinforced STKM	ø15-110	15AH2-110	Mg	203mm	Post 180 Direct	with lamp mount*			
SF23	MOBIE34-CGO Boost DS 15AH2-110 24"	yes	-	24"x2.6"	68mm	640mm	80 100	-	COIL w/ Preload adjuster	44	Al	34	STKM	Black	1.5"to1-1/8" tapered(CTS), reinforced STKM	ø15-110	15AH2-110	Mg	203mm	Post 180 Direct	with lamp mount*			
SF22	MOBIE34-CGO Boost DS LO 15AH2-110 20"	yes	-	20"x2.6"	68mm	539mm	80 100	LO	COIL w/ Preload adjuster	44	Al	34	STKM	Black	1.5"to1-1/8" tapered(CTS), reinforced STKM	ø15-110	15AH2-110	Mg	203mm	Post 180 Direct	with lamp mount*			
SF22	MOBIE34-CGO Boost DS 15AH2-110 20"	yes	-	20"x2.6"	68mm	539mm	80 100	-	COIL w/ Preload adjuster	44	Al	34	STKM	Black	1.5"to1-1/8" tapered(CTS), reinforced STKM	ø15-110	15AH2-110	Mg	203mm	Post 180 Direct	with lamp mount*			

\*Front face on fork crown

SPECIFICATIONS

// 2125



S RLR-PCS  
FDS 700C



GRAVEL  
GVX

MODEL YEAR	MODEL NAME	MAIN SPECIFICATIONS										CROWN		STANCHION		STEERER TUBE		AXLE		BOTTOM CASE / BRAKE		
		E-Bike ready	Weight (g) w/o axle	Wheel / Max. suggested tire size	Max allowed Tire Width	Max allowed Tire O.D.	Travel (mm)	Damper	Spring	Offset (mm)	Mat.	DIA (mm)	Mat.	Finish	Size Material	O.L.D.	Axle	Mat.	Max rotor DIA	Brake mount		
SF24	GVX32-S EQ RLR-PCS FDS 15AH2 700C	no	-	700Cx45C	50mm	722mm	40 50 60	RLR-PCS	AIR (EQ)	45.4 46.2 47	Al	32	Al	Black	1.5"to1-1/8" tapered(CTS), Alloy	ø15-100	15AH2, (OP) 12AH	Mg	Flat 180mm	Flat 160 Direct		
SF24	GVX32-S EQ LOR-PCS FDS 15AH2 700C	no	-	700Cx45C	50mm	722mm	40 50 60	LOR-PCS	AIR (EQ)	45.4 46.2 47	Al	32	Al	Black	1.5"to1-1/8" tapered(CTS), Alloy	ø15-100	15AH2, (OP) 12AH	Mg	Flat 180mm	Flat 160 Direct		
SF24	GVX32-E EQ RLR FDS 15AH2 700C	no	-	700Cx45C	50mm	722mm	40 50 60	RLR	AIR (EQ)	45.4 46.2 47	Al	32	Al	Black	1.5"to1-1/8" tapered(CTS), Alloy	ø15-100	15AH2, (OP) 12AH	Mg	Flat 180mm	Flat 160 Direct		
SF24	GVX32-E EQ LOR FDS 15AH2 700C	no	-	700Cx45C	50mm	722mm	40 50 60	LOR	AIR (EQ)	45.4 46.2 47	Al	32	Al	Black	1.5"to1-1/8" tapered(CTS), Alloy	ø15-100	15AH2, (OP) 12AH	Mg	Flat 180mm	Flat 160 Direct		

SPECIFICATIONS

// 21025



E AIR LO 29"



GLOSS BLACK



MATT BLACK



GLOSS WHITE

MODEL YEAR	MODEL NAME	MAIN SPECIFICATIONS										CROWN		STANCHION		STEERER TUBE		AXLE		BOTTOM CASE / BRAKE		Note
		E-Bike ready	Weight (g) w/o axle	Wheel / Max. suggested tire size	Max allowed Tire Width	Max allowed Tire O.D.	Travel (mm)	Damper	Spring	Offset (mm)	Mat.	DIA (mm)	Mat.	Finish	Size	Material	O.L.D.	Axle	Mat.	Max rotor DIA	Brake mount	
SF24	NRX32-E AIR LOR DS 15AH2 29"	yes	-	29"x2.25"	58mm	747mm	63 75	LOR	AIR	46	Al	32	Al	Hard anodized, Black	1.5"to1-1/8" tapered(CTS), STKM, (OP) 1.5"to1-1/8" tapered(CTS), Alloy	ø15-100	15AH2	Mg	180mm	Post 180 Direct	with lamp mount*	
SF24	NRX32-D AIR LOR DS 15AH2 29"	yes	-	29"x2.25"	58mm	747mm	63 75	LOR	AIR	46	Al	32	STKM	Black	1.5"to1-1/8" tapered(CTS), STKM, (OP) 1.5"to1-1/8" tapered(CTS), Alloy	ø15-100	15AH2	Mg	180mm	Post 180 Direct	with lamp mount*	
SF24	NRX32-D COIL LOR DS 15AH2 29"	yes	-	29"x2.25"	58mm	747mm	63 75	LOR	COIL w/ Preload adjuster	46	Al	32	STKM	Black	1.5"to1-1/8" tapered(CTS), STKM, (OP) 1.5"to1-1/8" tapered(CTS), Alloy	ø15-100	15AH2	Mg	180mm	Post 180 Direct	with lamp mount*	

\*Front face on fork crown



GLOSS BLACK

MATT BLACK

GLOSS WHITE

CROSS

NRX

MODEL YEAR	MODEL NAME	MAIN SPECIFICATIONS										CROWN		STANCHION		STEERER TUBE		AXLE		BOTTOM CASE / BRAKE		
		E-Bike ready	Weight (g) w/o axle	Wheel / Max. suggested tire size	Max allowed Tire Width	Max allowed Tire O.D.	Travel (mm)	Damper	Spring	Offset (mm)	Mat.	DIA (mm)	Mat.	Finish	Size	Material	O.L.D.	Axle	Mat.	Max rotor DIA	Brake mount	
SF18	NRX-S RLR DS 15QLC32S 700C	no	1850	700Cx48C	50mm	722mm	63 75	RLR	AIR	46	Al	32	Al	Hard anodized, Black	1-1/8"(TS), Alloy, (OP) 1.5"to1-1/8" tapered(CTS), Alloy	ø15-100	15QLC32S	Mg	180mm	Post 160 Direct		
SF18	NRX-S LOR DS 15QLC32S 700C	no	1845	700Cx48C	50mm	722mm	63 75	LOR	AIR	46	Al	32	Al	Hard anodized, Black	1-1/8"(TS), Alloy, (OP) 1.5"to1-1/8" tapered(CTS), Alloy	ø15-100	15QLC32S	Mg	180mm	Post 160 Direct		
SF18	NRX-E RLR DS 15QLC32S 700C	no	1860	700Cx48C	50mm	722mm	63 75	RLR	AIR	46	Al	32	Al	Hard anodized, Black	1-1/8"(TS), Alloy, (OP) 1.5"to1-1/8" tapered(CTS), Alloy	ø15-100	15QLC32S	Mg	180mm	Post 160 Direct		
SF18	NRX-E LOR DS 15QLC32S 700C	no	1865	700Cx48C	50mm	722mm	63 75	LOR	AIR	46	Al	32	Al	Hard anodized, Black	1-1/8"(TS), Alloy, (OP) 1.5"to1-1/8" tapered(CTS), Alloy	ø15-100	15QLC32S	Mg	180mm	Post 160 Direct		

SPECIFICATIONS

// 21025

STANOUR

# NCX32

TREKKING

29"

27.5"

32mm

32-D COIL LO 29"



MODEL YEAR	MODEL NAME	MAIN SPECIFICATIONS										CROWN		STANCHION		STEERER TUBE		AXLE		BOTTOM CASE / BRAKE		Note
		E-Bike ready	Weight (g) w/o axle	Wheel / Max. suggested tire size	Max allowed Tire Width	Max allowed Tire O.D.	Travel (mm)	Damper	Spring	Offset (mm)	Mat.	DIA (mm)	Mat.	Finish	Size Material	O.L.D.	Axle	Mat.	Max rotor DIA	Brake mount		
SF21	NCX32-E AIR RL DS 29"	yes	-	29"x2.25"	58mm	747mm	63/75	RL	AIR	46	Al	32	Al	Hard anodized, Black	1.5"to1-1/8" tapered(CTS), STKM, (OP) 1.5"to1-1/8" tapered(CTS), Alloy	9-100	9mm-Dropout	Mg	180mm	Post 160 Direct	with lamp mount*	
SF21	NCX32-E AIR LO DS 29"	yes	2180	29"x2.25"	58mm	747mm	63/75	LO	AIR	46	Al	32	Al	Hard anodized, Black	1.5"to1-1/8" tapered(CTS), STKM, (OP) 1.5"to1-1/8" tapered(CTS), Alloy	9-100	9mm-Dropout	Mg	180mm	Post 160 Direct	with lamp mount*	
SF21	NCX32-E COIL RL DS 29"	yes	-	29"x2.25"	58mm	747mm	63/75	RL	COIL w/ Preload adjuster	46	Al	32	Al	Hard anodized, Black	1.5"to1-1/8" tapered(CTS), STKM, (OP) 1.5"to1-1/8" tapered(CTS), Alloy	9-100	9mm-Dropout	Mg	180mm	Post 160 Direct	with lamp mount*	
SF21	NCX32-E COIL LO DS 29"	yes	-	29"x2.25"	58mm	747mm	63/75	LO	COIL w/ Preload adjuster	46	Al	32	Al	Hard anodized, Black	1.5"to1-1/8" tapered(CTS), STKM, (OP) 1.5"to1-1/8" tapered(CTS), Alloy	9-100	9mm-Dropout	Mg	180mm	Post 160 Direct	with lamp mount*	
SF24	NCX32-D AIR RL DS 29"	yes	-	29"x2.25"	58mm	747mm	63/75	RL	AIR	46	Al	32	STKM	Black	1.5"to1-1/8" tapered(CTS), STKM, (OP) 1.5"to1-1/8" tapered(CTS), Alloy	9-100	9mm-Dropout	Mg	180mm	Post 160 Direct	with lamp mount*	
SF24	NCX32-D AIR LO DS 29"	yes	-	29"x2.25"	58mm	747mm	63/75	LO	AIR	46	Al	32	STKM	Black	1.5"to1-1/8" tapered(CTS), STKM, (OP) 1.5"to1-1/8" tapered(CTS), Alloy	9-100	9mm-Dropout	Mg	180mm	Post 160 Direct	with lamp mount*	
SF21	NCX32-D COIL RL DS 29"	yes	-	29"x2.25"	58mm	747mm	63/75	RL	COIL w/ Preload adjuster	46	Al	32	STKM	Black	1.5"to1-1/8" tapered(CTS), STKM, (OP) 1.5"to1-1/8" tapered(CTS), Alloy	9-100	9mm-Dropout	Mg	180mm	Post 160 Direct	with lamp mount*	
SF21	NCX32-D COIL LO DS 29"	yes	2560	29"x2.25"	58mm	747mm	63/75	LO	COIL w/ Preload adjuster	46	Al	32	STKM	Black	1.5"to1-1/8" tapered(CTS), STKM, (OP) 1.5"to1-1/8" tapered(CTS), Alloy	9-100	9mm-Dropout	Mg	180mm	Post 160 Direct	with lamp mount*	

\*Front face on fork crown

TREKKING

NCX32

SPECIFICATIONS

// 2105

SUNTOUR

# NCX32

TREKKING

29"

27.5"

32mm

32-D COIL LO 29"



GLOSS BLACK

MATT BLACK

GLOSS WHITE

TREKKING

NCX32

MODEL YEAR	MODEL NAME	MAIN SPECIFICATIONS										CROWN		STANCHION		STEERER TUBE		AXLE		BOTTOM CASE / BRAKE		Note
		E-Bike ready	Weight (g) w/o axle	Wheel / Max. suggested tire size	Max allowed Tire Width	Max allowed Tire O.D.	Travel (mm)	Damper	Spring	Offset (mm)	Mat.	DIA (mm)	Mat.	Finish	Size	Material	O.L.D.	Axle	Mat.	Max rotor DIA	Brake mount	
SF21	NCX32-E AIR RL DS 27.5"	yes	-	27.5"x2.25"	58mm	708mm	63/75	RL	AIR	46	Al	32	Al	Hard anodized, Black	1.5"to1-1/8" tapered(CTS), STKM, (OP) 1.5"to1-1/8" tapered(CTS), Alloy	9-100	9mm-Dropout	Mg	180mm	Post 160 Direct	with lamp mount*	
SF21	NCX32-E AIR LO DS 27.5"	yes	2120	27.5"x2.25"	58mm	708mm	63/75	LO	AIR	46	Al	32	Al	Hard anodized, Black	1.5"to1-1/8" tapered(CTS), STKM, (OP) 1.5"to1-1/8" tapered(CTS), Alloy	9-100	9mm-Dropout	Mg	180mm	Post 160 Direct	with lamp mount*	
SF21	NCX32-E COIL RL DS 27.5"	yes	-	27.5"x2.25"	58mm	708mm	63/75	RL	COIL w/ Preload adjuster	46	Al	32	Al	Hard anodized, Black	1.5"to1-1/8" tapered(CTS), STKM, (OP) 1.5"to1-1/8" tapered(CTS), Alloy	9-100	9mm-Dropout	Mg	180mm	Post 160 Direct	with lamp mount*	
SF21	NCX32-E COIL LO DS 27.5"	yes	-	27.5"x2.25"	58mm	708mm	63/75	LO	COIL w/ Preload adjuster	46	Al	32	Al	Hard anodized, Black	1.5"to1-1/8" tapered(CTS), STKM, (OP) 1.5"to1-1/8" tapered(CTS), Alloy	9-100	9mm-Dropout	Mg	180mm	Post 160 Direct	with lamp mount*	
SF24	NCX32-D AIR RL DS 27.5"	yes	-	27.5"x2.25"	58mm	708mm	63/75	RL	AIR	46	Al	32	STKM	Black	1.5"to1-1/8" tapered(CTS), STKM, (OP) 1.5"to1-1/8" tapered(CTS), Alloy	9-100	9mm-Dropout	Mg	180mm	Post 160 Direct	with lamp mount*	
SF24	NCX32-D AIR LO DS 27.5"	yes	-	27.5"x2.25"	58mm	708mm	63/75	LO	AIR	46	Al	32	STKM	Black	1.5"to1-1/8" tapered(CTS), STKM, (OP) 1.5"to1-1/8" tapered(CTS), Alloy	9-100	9mm-Dropout	Mg	180mm	Post 160 Direct	with lamp mount*	
SF21	NCX32-D COIL RL DS 27.5"	yes	-	27.5"x2.25"	58mm	708mm	63/75	RL	COIL w/ Preload adjuster	46	Al	32	STKM	Black	1.5"to1-1/8" tapered(CTS), STKM, (OP) 1.5"to1-1/8" tapered(CTS), Alloy	9-100	9mm-Dropout	Mg	180mm	Post 160 Direct	with lamp mount*	
SF21	NCX32-D COIL LO DS 27.5"	yes	2500	27.5"x2.25"	58mm	708mm	63/75	LO	COIL w/ Preload adjuster	46	Al	32	STKM	Black	1.5"to1-1/8" tapered(CTS), STKM, (OP) 1.5"to1-1/8" tapered(CTS), Alloy	9-100	9mm-Dropout	Mg	180mm	Post 160 Direct	with lamp mount*	

\*Front face on fork crown

SPECIFICATIONS

// 21025

SFSAJOUR

D LO AIR 700C

E RL 700C



MODEL YEAR	MODEL NAME	MAIN SPECIFICATIONS										CROWN			STANCHION			STEERER TUBE		AXLE		BOTTOM CASE / BRAKE		
		E-Bike ready	Weight (g) w/o axle	Wheel / Max. suggested tire size	Max allowed Tire Width	Max allowed Tire O.D.	Travel (mm)	Damper	Spring	Offset (mm)	Mat.	DIA (mm)	Mat.	Finish	Size	Material	O.L.D.	Axle	Mat.	Max rotor DIA	Brake mount	Note		
SF17	NCX-E RL DS 15QLC32S 700C	no	1770	700Cx48C	50mm	722mm	50-63	RL	AIR	41,7	Al	30	Al	Hard anodized/Black	1-1/8"(TS), STKM, (OP) 1-1/8"(TS), Alloy/1.5"to1-1/8" tapered(CTS), Alloy	ø15-100	15QLC32S	Mg	180mm	Post 160 Direct	with lamp mount*			
SF17	NCX-E LO DS 15QLC32S 700C	no	1750	700Cx48C	50mm	722mm	50-63	LO	AIR	41,7	Al	30	Al	Hard anodized/Black	1-1/8"(TS), STKM, (OP) 1-1/8"(TS), Alloy/1.5"to1-1/8" tapered(CTS), Alloy	ø15-100	15QLC32S	Mg	180mm	Post 160 Direct	with lamp mount*			
SF17	NCX-D AIR RL DS 15QLC32S 700C	no	-	700Cx48C	50mm	722mm	50-63	RL	AIR	41,7	Al	30	STKM	Black	1-1/8"(TS), STKM, (OP) 1-1/8"(TS), Alloy/1.5"to1-1/8" tapered(CTS), Alloy	ø15-100	15QLC32S	Mg	180mm	Post 160 Direct	with lamp mount*			
SF17	NCX-D AIR LO DS 15QLC32S 700C	no	-	700Cx48C	50mm	722mm	50-63	LO	AIR	41,7	Al	30	STKM	Black	1-1/8"(TS), STKM, (OP) 1-1/8"(TS), Alloy/1.5"to1-1/8" tapered(CTS), Alloy	ø15-100	15QLC32S	Mg	180mm	Post 160 Direct	with lamp mount*			
SF17	NCX-D COIL RL DS 15QLC32S 700C	no	-	700Cx48C	50mm	722mm	50-63	RL	COIL w/ Preload adjuster	41,7	Al	30	STKM	Black	1-1/8"(TS), STKM, (OP) 1-1/8"(TS), Alloy/1.5"to1-1/8" tapered(CTS), Alloy	ø15-100	15QLC32S	Mg	180mm	Post 160 Direct	with lamp mount*			
SF17	NCX-D COIL LO DS 15QLC32S 700C	no	-	700Cx48C	50mm	722mm	50-63	LO	COIL w/ Preload adjuster	41,7	Al	30	STKM	Black	1-1/8"(TS), STKM, (OP) 1-1/8"(TS), Alloy/1.5"to1-1/8" tapered(CTS), Alloy	ø15-100	15QLC32S	Mg	180mm	Post 160 Direct	with lamp mount*			

\*Small size type on the center of brace



32 AIR LO 29"



TREKKING

NX1

		MAIN SPECIFICATIONS									CROWN		STANCHION		STEERER TUBE		AXLE		BOTTOM CASE / BRAKE		
MODEL YEAR	MODEL NAME	E-Bike ready	Weight (g) w/o axle	Wheel / Max. suggested tire size	Max allowed Tire Width	Max allowed Tire O.D.	Travel (mm)	Damper	Spring	Offset (mm)	Mat.	DIA (mm)	Mat.	Finish	Size Material	O.L.D.	Axle	Mat.	Max rotor DIA	Brake mount	Note
SF23	NX1-32-Boost AIR RL DS 15AH2-110 29"	yes	-	29"x2.25"	58mm	754mm	80 100	RL	AIR	46	Al	32	STKM	Black	1.5"to1-1/8" tapered(CTS), Alloy	ø15-110	15AH2-110	Al	203mm	Post 180 Direct	with lamp mount*
SF23	NX1-32-Boost AIR LO DS 15AH2-110 29"	yes	-	29"x2.25"	58mm	754mm	80 100	LO	AIR	46	Al	32	STKM	Black	1.5"to1-1/8" tapered(CTS), Alloy	ø15-110	15AH2-110	Al	203mm	Post 180 Direct	with lamp mount*
SF24	NX1-32 AIR RL DS 15AH2 29"	yes	-	29"x2.25"	58mm	754mm	80 100	RL	AIR	46	Al	32	STKM	Black	1.5"to1-1/8" tapered(CTS), Alloy	ø15-100	15AH2	Al	180mm	Post 180 Direct	with lamp mount*
SF24	NX1-32 AIR LO DS 15AH2 29"	yes	-	29"x2.25"	58mm	754mm	80 100	LO	AIR	46	Al	32	STKM	Black	1.5"to1-1/8" tapered(CTS), Alloy	ø15-100	15AH2	Al	180mm	Post 180 Direct	with lamp mount*
SF22	NX1 COIL RL DS 700C	no	-	700Cx48C	50mm	722mm	50 63	RL	COIL w/ Preload adjuster	43	Al	30	STKM	Black	1-1/8"(TS), Alloy, (OP) 1.5"to1-1/8" tapered(CTS), Alloy	9-100	9mm-Dropout	Al	180mm	Post 160 Direct	with lamp mount**
SF22	NX1 COIL LO DS 700C	no	-	700Cx48C	50mm	722mm	50 63	LO	COIL w/ Preload adjuster	43	Al	30	STKM	Black	1-1/8"(TS), Alloy, (OP) 1.5"to1-1/8" tapered(CTS), Alloy	9-100	9mm-Dropout	Al	180mm	Post 160 Direct	with lamp mount**

\*Front face on fork crown \*\*Small size type on the center of brace

SPECIFICATIONS

// 21025



32 NLO 29"



30 NLO 29"



		MAIN SPECIFICATIONS										CROWN			STANCHION			STEERER TUBE		AXLE		BOTTOM CASE / BRAKE		
MODEL YEAR	MODEL NAME	E-Bike ready	Weight (g) w/o axle	Wheel / Max. suggested tire size	Max allowed Tire Width	Max allowed Tire O.D.	Travel (mm)	Damper	Spring	Offset (mm)	Mat.	DIA (mm)	Mat.	Finish	Size Material	O.L.D.	Axle	Mat.	Max rotor DIA	Brake mount	Note			
SF23	NVX32-Boost RL DS 15AH2-110 29"	yes	-	29"x2.25"	58mm	754mm	63 80	RL	COIL w/ Preload adjuster	46	Al	32	STKM	Black	1.5"to1-1/8" tapered(CTS), STKM	ø15-110	15AH2-110	Al	203mm	Post 180 Direct	with lamp mount*			
SF23	NVX32-Boost NLO DS 15AH2-110 29"	yes	-	29"x2.25"	58mm	754mm	63 80	NLO	COIL w/ Preload adjuster	46	Al	32	STKM	Black	1.5"to1-1/8" tapered(CTS), STKM	ø15-110	15AH2-110	Al	203mm	Post 180 Direct	with lamp mount*			
SF23	NVX32-Boost DS 15AH2-110 29"	yes	-	29"x2.25"	58mm	754mm	63 80	-	COIL w/ Preload adjuster	46	Al	32	STKM	Black	1.5"to1-1/8" tapered(CTS), STKM	ø15-110	15AH2-110	Al	203mm	Post 180 Direct	with lamp mount*			
SF22	NVX30 RL DS 29"	no	-	29"x2.25"	58mm	747mm	63 80 100	RL	COIL w/ Preload adjuster	46	Al	30	STKM	Cr-plating	1-1/8"(TS), STKM	9-100	9mm-Dropout	Al	180mm	Post 160 Direct	with lamp mount*			
SF22	NVX30 NLO DS 29"	no	3050	29"x2.25"	58mm	747mm	63 80 100	NLO	COIL w/ Preload adjuster	46	Al	30	STKM	Cr-plating	1-1/8"(TS), STKM	9-100	9mm-Dropout	Al	180mm	Post 160 Direct	with lamp mount*			
SF22	NVX30 DS 29"	no	-	29"x2.25"	58mm	747mm	63 80 100	-	COIL w/ Preload adjuster	46	Al	30	STKM	Cr-plating	1-1/8"(TS), STKM	9-100	9mm-Dropout	Al	180mm	Post 160 Direct	with lamp mount*			
SF22	NVX30 RL DS 27.5"	no	-	27.5"x2.25"	58mm	708mm	63 80 100	RL	COIL w/ Preload adjuster	46	Al	30	STKM	Cr-plating	1-1/8"(TS), STKM	9-100	9mm-Dropout	Al	180mm	Post 160 Direct	with lamp mount*			
SF22	NVX30 NLO DS 27.5"	no	-	27.5"x2.25"	58mm	708mm	63 80 100	NLO	COIL w/ Preload adjuster	46	Al	30	STKM	Cr-plating	1-1/8"(TS), STKM	9-100	9mm-Dropout	Al	180mm	Post 160 Direct	with lamp mount*			
SF22	NVX30 DS 27.5"	no	-	27.5"x2.25"	58mm	708mm	63 80 100	-	COIL w/ Preload adjuster	46	Al	30	STKM	Cr-plating	1-1/8"(TS), STKM	9-100	9mm-Dropout	Al	180mm	Post 160 Direct	with lamp mount*			
SF23	NVX32 RL DS 15AH2 29"	yes	-	29"x2.25"	58mm	754mm	63 80	RL	COIL w/ Preload adjuster	46	Al	32	STKM	Black	1.5"to1-1/8" tapered(CTS), STKM	ø15-100	15AH2	Al	180mm	Post 180 Direct	with lamp mount*			
SF23	NVX32 NLO DS 15AH2 29"	yes	-	29"x2.25"	58mm	754mm	63 80	NLO	COIL w/ Preload adjuster	46	Al	32	STKM	Black	1.5"to1-1/8" tapered(CTS), STKM	ø15-100	15AH2	Al	180mm	Post 180 Direct	with lamp mount*			
SF23	NVX32 DS 15AH2 29"	yes	-	29"x2.25"	58mm	754mm	63 80	-	COIL w/ Preload adjuster	46	Al	32	STKM	Black	1.5"to1-1/8" tapered(CTS), STKM	ø15-100	15AH2	Al	180mm	Post 180 Direct	with lamp mount*			

\*Front face on fork crown

E25-C NLO 700C



GLOSS BLACK

MATT BLACK

GLOSS WHITE

CROSS/TREKKING

NEX

MODEL YEAR	MODEL NAME	MAIN SPECIFICATIONS										CROWN		STANCHION		STEERER TUBE		AXLE		BOTTOM CASE / BRAKE		Note
		E-Bike ready	Weight (g) w/o axle	Wheel / Max. suggested tire size	Max allowed Tire Width	Max allowed Tire O.D.	Travel (mm)	Damper	Spring	Offset (mm)	Mat.	DIA (mm)	Mat.	Finish	Size Material	O.L.D.	Axle	Mat.	Max rotor DIA	Brake mount		
SF19	NEX-E25-C NLO DS 15QLC32 700C	yes	2655	700Cx52C	54mm	738mm	50 63 75	NLO	COIL w/ Preload adjuster	44	Al	30	STKM	Cr-plating	1-1/8"(TS), STKM, (OP) 1.5"to1-1/8" tapered(CTS), STKM	ø15-100	15QLC32S	Al	180mm	Post 160 Direct	with lamp mount*	
SF18	NEX-E25-C DS 15QLC32 700C	yes	2655	700Cx52C	54mm	738mm	50 63 75	-	COIL w/ Preload adjuster	44	Al	30	STKM	Cr-plating	1-1/8"(TS), STKM, (OP) 1.5"to1-1/8" tapered(CTS), STKM	ø15-100	15QLC32S	Al	180mm	Post 160 Direct	with lamp mount*	
SF19	NEX-E25 NLO DS 15QLC32 700C	yes	2655	700Cx52C	54mm	738mm	50 63 75	NLO	COIL w/ Preload adjuster	44	Al	30	STKM	Cr-plating	1-1/8"(TS), STKM, (OP) 1.5"to1-1/8" tapered(CTS), STKM	ø15-100	15QLC32S	Al	180mm	Post 160 Direct	with lamp mount**	
SF17	NEX-E25 DS 15QLC32 700C	yes	2655	700Cx52C	54mm	738mm	50 63 75	-	COIL w/ Preload adjuster	44	Al	30	STKM	Cr-plating	1-1/8"(TS), STKM, (OP) 1.5"to1-1/8" tapered(CTS), STKM	ø15-100	15QLC32S	Al	180mm	Post 160 Direct	with lamp mount**	
SF19	NEX-E25 NLO DS 700C	yes	-	700Cx52C	54mm	738mm	50 63 75	NLO	COIL w/ Preload adjuster	44	Al	30	STKM	Cr-plating	1-1/8"(TS), STKM, (OP) 1.5"to1-1/8" tapered(CTS), STKM	9-100	9mm-Dropout	Al	180mm	Post 160 Direct	with lamp mount**	
SF19	NEX-E25 NLO P 700C	yes	-	700Cx52C	54mm	738mm	50 63 75	NLO	COIL w/ Preload adjuster	44	Al	30	STKM	Cr-plating	1-1/8"(TS), STKM, (OP) 1.5"to1-1/8" tapered(CTS), STKM	9-100	9mm-Dropout	Al	180mm	V-Brake+Post	with lamp mount**	
SF15	NEX-E25 DS 700C	yes	2420	700Cx52C	54mm	738mm	50 63 75	-	COIL w/ Preload adjuster	44	Al	30	STKM	Cr-plating	1-1/8"(TS), STKM, (OP) 1.5"to1-1/8" tapered(CTS), STKM	9-100	9mm-Dropout	Al	180mm	Post 160 Direct	with lamp mount**	
SF14	NEX-E25 P 700C	yes	-	700Cx52C	54mm	738mm	50 63 75	-	COIL w/ Preload adjuster	44	Al	30	STKM	Cr-plating	1-1/8"(TS), STKM, (OP) 1.5"to1-1/8" tapered(CTS), STKM	9-100	9mm-Dropout	Al	180mm	V-Brake+Post	with lamp mount**	
SF19	NEX-E25 P+DS NLO 26"	yes	-	26"x2.1"	54mm	678mm	50 63	NLO	COIL w/ Preload adjuster	44	Al	30	STKM	Cr-plating	1-1/8"(TS), STKM, (OP) 1.5"to1-1/8" tapered(CTS), STKM	9-100	9mm-Dropout	Al	180mm	V-Brake+Post	with lamp mount**	
SF18	NEX-E25 P+DS 26"	yes	-	26"x2.1"	54mm	678mm	50 63	-	COIL w/ Preload adjuster	44	Al	30	STKM	Cr-plating	1-1/8"(TS), STKM, (OP) 1.5"to1-1/8" tapered(CTS), STKM	9-100	9mm-Dropout	Al	180mm	V-Brake+Post	with lamp mount**	

\*Front face on fork crown \*\*Small size type on the center of brace

SPECIFICATIONS

// 21025

SFSAJOUR



GLOSS BLACK



MATT BLACK



GLOSS WHITE

		MAIN SPECIFICATIONS										CROWN		STANCHION		STEERER TUBE		AXLE		BOTTOM CASE / BRAKE		
MODEL YEAR	MODEL NAME	E-Bike ready	Weight (g) w/o axle	Wheel / Max. suggested tire size	Max allowed Tire Width	Max allowed Tire O.D.	Travel (mm)	Damper	Spring	Offset (mm)	Mat.	DIA (mm)	Mat.	Finish	Size Material	O.L.D.	Axle	Mat.	Max rotor DIA	Brake mount	Note	
SF20	NEX RL DS 700C	no	2655	700Cx48C	50mm	738mm	50 63	RL	COIL w/ Preload adjuster	40	Al	28	STKM	Cr-plating	1-1/8"(TS), STKM	9-100	9mm-Dropout	Al	180mm	Post 160 Direct	with lamp mount*	
SF20	NEX RL P 700C	no	2320	700Cx48C	50mm	738mm	50 63	RL	COIL w/ Preload adjuster	40	Al	28	STKM	Cr-plating	1-1/8"(TS), STKM	9-100	9mm-Dropout	Al	-	V-Brake	with lamp mount*	
SF20	NEX HLO DS 700C	no	2669	700Cx48C	50mm	738mm	50 63	HLO	COIL w/ Preload adjuster	40	Al	28	STKM	Cr-plating	1-1/8"(TS), STKM	9-100	9mm-Dropout	Al	180mm	Post 160 Direct	with lamp mount*	
SF20	NEX HLO P 700C	no	-	700Cx48C	50mm	738mm	50 63	HLO	COIL w/ Preload adjuster	40	Al	28	STKM	Cr-plating	1-1/8"(TS), STKM	9-100	9mm-Dropout	Al	-	V-Brake	with lamp mount*	
SF20	NEX DS 700C	no	2420	700Cx48C	50mm	738mm	50 63	-	COIL w/ Preload adjuster	40	Al	28	STKM	Cr-plating	1-1/8"(TS), STKM	9-100	9mm-Dropout	Al	180mm	Post 160 Direct	with lamp mount*	
SF20	NEX P 700C	no	-	700Cx48C	50mm	738mm	50 63	-	COIL w/ Preload adjuster	40	Al	28	STKM	Cr-plating	1-1/8"(TS), STKM	9-100	9mm-Dropout	Al	-	V-Brake	with lamp mount*	
SF21	NEX HLO DS 26"	no	2504	26"x2.1"	54mm	684mm	50 63	HLO	COIL w/ Preload adjuster	40	Al	28	STKM	Cr-plating	1-1/8"(TS), STKM	9-100	9mm-Dropout	Al	180mm	Post 160 Direct	with lamp mount*	
SF21	NEX DS 26"	no	2305	26"x2.1"	54mm	684mm	50 63	-	COIL w/ Preload adjuster	40	Al	28	STKM	Cr-plating	1-1/8"(TS), STKM	9-100	9mm-Dropout	Al	180mm	Post 160 Direct	with lamp mount*	
SF21	NEX P 26"	no	-	26"x2.1"	54mm	684mm	63	-	COIL w/ Preload adjuster	40	Al	28	STKM	Cr-plating	1-1/8"(TS), STKM	9-100	9mm-Dropout	Al	-	V-Brake	with lamp mount*	

\*Small size type on the center of brace

# CR85-E25

URBAN / UTILITY

700<sup>G</sup>

26"

30mm

CR85 E25 LO 700C



URBAN / UTILITY

CR85-E25

MODEL YEAR	MODEL NAME	MAIN SPECIFICATIONS											CROWN		STANCHION		STEERER TUBE		AXLE		BOTTOM CASE / BRAKE		
		E-Bike ready	Weight (g) w/o axle	Wheel / Max. suggested tire size	Max allowed Tire Width	Max allowed Tire O.D.	Travel (mm)	Damper	Spring	Offset (mm)	Mat.	DIA (mm)	Mat.	Finish	Size Material	O.L.D.	Axle	Mat.	Max rotor DIA	Brake mount	Note		
SF14	CR85-E25 P LO 700C	yes	2700	700Cx48C	50mm	722mm	50 63	LO	COIL w/ Preload adjuster	AC4C	30	STKM	Cr-plating	116	1-1/8"(TS), STKM	9-100	9mm-Dropout	Al	-	V-Brake	with lamp mount*		
SF14	CR85-E25 P 700C	yes	2485	700Cx48C	50mm	722mm	50 63	-	COIL w/ Preload adjuster	AC4C	30	STKM	Cr-plating	116	1-1/8"(TS), STKM	9-100	9mm-Dropout	Al	-	V-Brake	with lamp mount*		
SF14	CR85-E25-R LO 700C	yes	2655	700Cx48C	50mm	722mm	40	LO	COIL w/ Preload adjuster	AC4C	30	STKM	Cr-plating	116	1-1/8"(TS), STKM	9-100	9mm-Dropout	Al	-	Roller	with lamp mount*		
SF14	CR85-E25 R 700C	yes	2438	700Cx48C	50mm	722mm	40	-	COIL w/ Preload adjuster	AC4C	30	STKM	Cr-plating	116	1-1/8"(TS), STKM	9-100	9mm-Dropout	Al	-	Roller	with lamp mount*		
SF18	CR85-E25 P LO 26"	yes	-	26"x2.1"	54mm	684mm	50	LO	COIL w/ Preload adjuster	AC4C	30	STKM	Cr-plating	116	1-1/8"(TS), STKM	9-100	9mm-Dropout	Al	-	V-Brake	with lamp mount*		
SF18	CR85-E25 P 26"	yes	-	26"x2.1"	54mm	684mm	50	-	COIL w/ Preload adjuster	AC4C	30	STKM	Cr-plating	116	1-1/8"(TS), STKM	9-100	9mm-Dropout	Al	-	V-Brake	with lamp mount*		

\*Small size type on the center of brace

SPECIFICATIONS

// 21025



# NCX SUSPENSION SEATPOST URBAN / UTILITY



MODEL YEAR	MODEL NAME	Travel (mm)	Seat Clamp	FRAME		POST		SPRING		ARM			
				Upper	Lower	Diameter (mm)	Length (mm)	Spring	Pre-load adjust	Design	Material	Connecting	Spring Option
SP25	NCX-COIL	50	Slide clamp, radial detent, wide angle range	Forged	Forged	31.6, 25 setback	400	Coil (Medium)	Yes	Parallelogram design	Al	Brass bushings	Hard Soft
SP25	NCX-COIL	50	Slide clamp, radial detent, wide angle range	Forged	Forged	31.6, 25 setback	350	Coil (Medium)	Yes	Parallelogram design	Al	Brass bushings	Hard Soft
SP25	NCX-COIL	50	Slide clamp, radial detent, wide angle range	Forged	Forged	30.9, 25 setback	400	Coil (Medium)	Yes	Parallelogram design	Al	Brass bushings	Hard Soft
SP25	NCX-COIL	50	Slide clamp, radial detent, wide angle range	Forged	Forged	30.9, 25 setback	350	Coil (Medium)	Yes	Parallelogram design	Al	Brass bushings	Hard Soft
SP12	NCX-COIL	50	Slide clamp, radial detent, wide angle range	Forged	Forged	27.2, 25 setback	400	Coil (Medium)	Yes	Parallelogram design	Al	Brass bushings	Hard Soft
SP12	NCX-COIL	50	Slide clamp, radial detent, wide angle range	Forged	Forged	27.2, 25 setback	350	Coil (Medium)	Yes	Parallelogram design	Al	Brass bushings	Hard Soft

# OTIS SUSPENSION SEATPOST ALL RIDING STYLES



MODEL YEAR	MODEL NAME	Travel (mm)	Seat Clamp	FRAME		POST		INSERTION LENGTH		Up / Down System	Cable Length
				Upper	Lower	Diameter (mm)	Length (mm)	Min. (mm)	In frame (mm)		
SP25	OTIS	75	Double clamp with two bolts fixing	Forged	Forged	34.9 / 0 setback 31.6 / 0 setback 30.9 / 0 setback	296	100	153	Air cartridge system with remote lever	STD: 1200L OP1: 1500L OP2: 1800L
SP25	OTIS	100	Double clamp with two bolts fixing	Forged	Forged	34.9 / 0 setback 31.6 / 0 setback 30.9 / 0 setback	346	100	178	Air cartridge system with remote lever	STD: 1200L OP1: 1500L OP2: 1800L
SP25	OTIS	125	Double clamp with two bolts fixing	Forged	Forged	34.9 / 0 setback 31.6 / 0 setback 30.9 / 0 setback	406	100	203	Air cartridge system with remote lever	STD: 1200L OP1: 1500L OP2: 1800L
SP25	OTIS	150	Double clamp with two bolts fixing	Forged	Forged	34.9 / 0 setback 31.6 / 0 setback 30.9 / 0 setback	451	100	235	Air cartridge system with remote lever	STD: 1200L OP1: 1500L OP2: 1800L
SP25	OTIS	175	Double clamp with two bolts fixing	Forged	Forged	34.9 / 0 setback 31.6 / 0 setback 30.9 / 0 setback	502	110	248	Air cartridge system with remote lever	STD: 1200L OP1: 1500L OP2: 1800L
SP25	OTIS	200	Double clamp with two bolts fixing	Forged	Forged	34.9 / 0 setback 31.6 / 0 setback 30.9 / 0 setback	550	110	278	Air cartridge system with remote lever	STD: 1200L OP1: 1500L OP2: 1800L

ALL RIDING STYLES

OTIS SUSPENSION SEATPOST

SPECIFICATIONS

// 21025

SHIMANO



MODEL YEAR	MODEL NAME	WEIGHT (g)	DAMPER	TRAVEL (INCH)	TRAVEL (METRIC)	TRAVEL (TRUNNION)	SPRING	FEATURE
RS24	TRIAIR-3CR-SV	-	3CR	200 x 57 mm 216 x 63 mm	210 x 47.5 / 50 / 52.5 / 55 mm 230 x 57.5 / 60 / 62.5 / 65 mm		AIR	1. Spring curve adjustment with air volume spacers 2. Air volume descriptions: SV_Small positive air volume and small negative air volume. LVN_Small positive air volume and large negative air volume.
RS24	TRIAIR-3CR-LVN	-	3CR					
RS24	TRIAIR-R-SV	-	R					
RS24	TRIAIR-R-LVN	-	R					
RS24	TRIAIR-3CR-SV-TR	-	3CR			185 x 47.5 / 50 / 52.5 / 55 mm 205 x 57.5 / 60 / 62.5 / 65 mm 225 x 67.5 / 70 / 72.5 / 75 mm		
RS24	TRIAIR-3CR-LVN-TR	-	3CR					
RS24	TRIAIR-R-SV-TR	-	R					
RS24	TRIAIR-R-LVN-TR	-	R					



# TRIAIR2 ENDURO / TRAIL



MODEL YEAR	MODEL NAME	WEIGHT (g)	DAMPER	TRAVEL (INCH)	TRAVEL (METRIC)	TRAVEL (TRUNNION)	SPRING	FEATURE
RS24	TRIAIR2-3CR-LVN	-	3CR	200 x 51 mm	190 x 37.5 / 40 / 42.5 / 45 mm 210 x 47.5 / 50 / 52.5 / 55 mm 230 x 57.5 / 60 / 62.5 / 65 mm 250 x 67.5 / 70 / 72.5 / 75 mm		AIR	<ol style="list-style-type: none"> <li>1. Bulge shape body</li> <li>2. 8 clicks rebound</li> <li>3. Spring curve adjustment with air volume spacers</li> <li>4. IFP system</li> <li>5. Air volume descriptions: LVN_Small positive air volume and Large Negative air Volume. SV_Small positive air volume and small negative air volume.</li> </ol>
RS24	TRIAIR2-3CR-SV	-	3CR					
RS24	TRIAIR2-2CR-LVN	-	2CR					
RS24	TRIAIR2-2CR-SV	-	2CR					
RS24	TRIAIR2-R-LVN	-	R					
RS24	TRIAIR2-R-SV	-	R					
RS24	TRIAIR2-3CR-LVN-TR	-	3CR					
RS24	TRIAIR2-3CR-SV-TR	-	3CR					
RS24	TRIAIR2-2CR-LVN-TR	-	2CR					
RS24	TRIAIR2-2CR-SV-TR	-	2CR					
RS24	TRIAIR2-R-LVN-TR	-	R					
RS24	TRIAIR2-R-SV-TR	-	R					

# EDGE-X URBAN / CROSS COUNTRY / TRAIL



MODEL YEAR	MODEL NAME	WEIGHT (g)	DAMPER	TRAVEL (INCH)	TRAVEL (METRIC)	TRAVEL (TRUNNION)	SPRING	FEATURE
RS24	EDGE-X-2CR-LV	-	2CR	152 x 31 mm 165 x 38 mm 184 x 44 mm	170 x 27.5 / 30 / 32.5 / 35 mm 190 x 37.5 / 40 / 42.5 / 45 mm 210 x 47.5 / 50 / 52.5 / 55 mm	-	AIR	Air volume descriptions: LV_Large positive air volume and large negative air volume. SV_Small positive air volume and small negative air volume.
RS24	EDGE-X-2CR-SV	-	2CR					
RS24	EDGE-X-RC-LV	-	RC					
RS24	EDGE-X-RC-SV	-	RC					
RS24	EDGE-X-R-LV	-	R					
RS24	EDGE-X-R-SV	-	R					
RS24	EDGE-X-2CR-LV-TR	-	2CR	-	-	145 x 27.5 / 30 / 32.5 / 35 mm 165 x 37.5 / 40 / 42.5 / 45 mm 185 x 47.5 / 50 / 52.5 / 55 mm		
RS24	EDGE-X-2CR-SV-TR	-	2CR					
RS24	EDGE-X-RC-LV-TR	-	RC					
RS24	EDGE-X-RC-SV-TR	-	RC					
RS24	EDGE-X-R-LV-TR	-	R					
RS24	EDGE-X-R-SV-TR	-	R					

# EDGE-EVO URBAN / CROSS COUNTRY / TRAIL



R-3CR REMOTE LOCK OUT



TWIN LEVER AVAILABLE



MODEL YEAR	MODEL NAME	WEIGHT (g)	DAMPER	TRAVEL (INCH)	TRAVEL (METRIC)	TRAVEL (TRUNNION)	SPRING	FEATURE
RS25	EDGE-EVO-2CR-LVN	-	2CR	200 x 51 mm	190 x 37.5 / 40 / 42.5 / 45 mm 210 x 47.5 / 50 / 52.5 / 55 mm 230 x 57.5 / 60 / 62.5 / 65 mm	-	AIR	1. w/Glide ring 2. Spring curve adjustment with air volume spacers 3. Air volume descriptions LVN_Small positive air volume and large negative air volume. LV_Large positive air volume and large negative air volume.
RS25	EDGE-EVO-2CR-LV	-	2CR					
RS25	EDGE-EVO-R-LVN	-	R					
RS25	EDGE-EVO-R-LV	-	R					
RS25	EDGE-EVO-2CR-LVN-TR	-	2CR	-	-	165 x 37.5 / 40 / 42.5 / 45 mm 185 x 47.5 / 50 / 52.5 / 55 mm 205 x 57.5 / 60 / 62.5 / 65 mm		
RS25	EDGE-EVO-2CR-LVN-TR	-	2CR					
RS25	EDGE-EVO-R-LV-TR	-	R					
RS25	EDGE-EVO-R-LV-TR	-	R					
RS25	EDGE-EVO-R-2CR-LVN	-	R-2CR	200 x 51 mm	190 x 37.5 / 40 / 42.5 / 45 mm 210 x 47.5 / 50 / 52.5 / 55 mm 230 x 57.5 / 60 / 62.5 / 65 mm	-		
RS25	EDGE-EVO-R-2CR-LV	-	R-2CR					
RS25	EDGE-EVO-R-2CR-LVN-TR	-	R-2CR					
RS25	EDGE-EVO-R-2CR-LV-TR	-	R-2CR	-	-	165 x 37.5 / 40 / 42.5 / 45 mm 185 x 47.5 / 50 / 52.5 / 55 mm 205 x 57.5 / 60 / 62.5 / 65 mm		

# EDGE-PLUS

URBAN / CROSS COUNTRY / TRAIL



MODEL YEAR	MODEL NAME	WEIGHT (g)	DAMPER	TRAVEL (INCH)	TRAVEL (METRIC)	TRAVEL (TRUNNION)	SPRING	FEATURE
RS21	EDGE-PLUS-2CR	340 (210x55)	2CR	152 x 31 mm 165 x 38 mm	170 x 27.5 / 30 / 32.5 / 35 mm			
RS21	EDGE-PLUS-RC	-	RC	184 x 44 mm 190 x 51 mm	190 x 37.5 / 40 / 42.5 / 45 mm 210 x 47.5 / 50 / 52.5 / 55 mm			
RS21	EDGE-PLUS-R	-	R	200 x 51 / 57 mm				
RS21	EDGE-PLUS-TR-2CR	321 (185x55)	2CR				AIR	Air spring with bigger air volume
RS21	EDGE-PLUS-TR-RC	318 (185x55)	RC			145 x 27.5 / 30 / 32.5 / 35 mm 165 x 37.5 / 40 / 42.5 / 45 mm 185 x 47.5 / 50 / 52.5 / 55 mm		
RS21	EDGE-PLUS-TR-R	-	R					

URBAN / XC / TRAIL

EDGE-PLUS

SPECIFICATIONS

// 21025

SR SUNTOUR



MODEL YEAR	MODEL NAME	WEIGHT (g)	DAMPER	TRAVEL (INCH)	TRAVEL (METRIC)	TRAVEL (TRUNNION)	SPRING	FEATURE
RS19	EDGE-LOR	-	LOR	152 x 31 mm 165 x 38 mm 184 x 44 mm 190 x 51 mm	170 x 27.5 / 30 / 32.5 / 35 mm 190 x 37.5 / 40 / 42.5 / 45 mm		AIR	
RS19	EDGE-LOR8	-	LOR8					
RS19	EDGE-RC	-	RC					
RS19	EDGE-R	-	R					
RS19	EDGE-TR-LOR	-	LOR			145 x 27.5 / 30 / 32.5 / 35 mm 165 x 37.5 / 40 / 42.5 / 45 mm 185 x 47.5 / 50 / 52.5 / 55 mm		
RS19	EDGE-TR-LOR8	-	LOR8					
RS19	EDGE-TR-RC	-	RC					
RS19	EDGE-TR-R	-	R					



MODEL YEAR	MODEL NAME	WEIGHT (g)	DAMPER	TRAVEL (INCH)	TRAVEL (METRIC)	TRAVEL (TRUNNION)	SPRING	FEATURE
RS25	RAIDON-LO	-	LO	152 x 31mm 165 x 38mm 184 x 44mm	170 x 30mm 170 x 35mm 190 x 40mm	-	AIR	FP cap being changed to hex type, easier for maintenance,
RS25	RAIDON-R	-	R	190 x 51mm	190 x 45mm			

# REMOTE LEVER

RL22-DUAL-L-2C-22



RL22-SINGLE-L-2C-22



RL22-SINGLE-U-2C-22



MODEL YEAR	MODEL NAME	FUNCTION	FEATURE	NOTE
RL22	DUAL-L-2C-22	2C-22	Remote lever for dual cable, left side dedicated mount position design, for 2 position compression adjust for front fork & rear shock, clamp dia.: 22.2mm	No. to be changed from "SL18SC-DUAL-RLO"
RL22	SINGLE-U-2C-22	2C-22	Remote lever for single cable, universal mount position design, for 2 position compression adjust for front fork or rear shock, clamp dia.: 22.2mm	No. to be changed from "SL15SC-RLO"
RL22	SINGLE-U-2C-32	2C-32	Remote lever for single cable, universal mount position design, for 2 position compression adjust for front fork or rear shock, clamp dia.: 31.8mm	-
RL22	SINGLE-L-2C-22	2C-22	Remote lever for single cable, left side dedicated mount position design, for 2 position compression adjust for front fork or rear shock, clamp dia.: 22.2mm	No. to be changed from "SL12SC-RLO"



RIDER PAULINE FERRAND-PRÉVOT  
 LOCATION WORLD CUP 2024  
 NOVE MESTO NA MORAVE, CZECH REPUBLIC  
 PHOTO ANDY VATHIS



## **SERVICE DEALER NETWORK**

### **BLESSED BY SR SUNTOUR TUNING BASE**

The SR SUNTOUR Service Dealer Network has been developed in line with our Quick Service Product philosophy, ensuring that it's as easy as possible for local dealers to maintain and service our products. In combination with individual dealer training, we are able to offer you the highest level of local service with competent and effective customer service. This is guaranteed through a permanent stock of essential spare parts which every Service Dealer carries. Regardless of whether it's the service or maintenance of your fork, first-time buyer consultation, old equipment or new, or in-depth enquiries about SR SUNTOUR products, the Service Dealer Network is there for you. [www.srsuntour.com/service](http://www.srsuntour.com/service)





# SR SUNTOUR SPECIAL SERVICE TOOLS



**SR SUNTOUR PROFESSIONAL MICROMETER ADJUSTABLE TORQUE WRENCH (ZFC161)**



**MTB ALLOY TOP CAP BOX WRENCH**  
27mm (ZFC160-R) / Trekking alloy top cap box wrench 21mm (ZFC159-R)

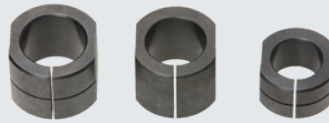

**VICE CARTRIDGE CLAMPS (FAT112)**



**SR SUNTOUR CANTILEVER BOSS REMOVER (FAT120)**



**PLASTIC PRELOAD ADJUSTER CAP TOOL for 3/8" ratchets (FAT110 & FAT111)**



**DUST SEAL INSTALLER**  
for 38mm (FAT106), 36mm (FAT105), 35mm (FAT104), 34mm (FAT103), 32mm (FAT102) and 30mm (FAT101) stanchions



**TOOL KIT BOX (FKA115)** with dust seal installer for 38mm (FAT106), 36mm (FAT105), 35mm (FAT104), 34mm (FAT103), 32mm (FAT102) and 30mm (FAT101) stanchions, vice cartridge clamps (FAT112)



**PRELOAD ADJUSTER REMOVER**  
for Trekking and MTB. Special plastic tool to open preload adjuster caps. (FAA122 & FAA086)



**SERVICE KITS**  
available under [www.srsuntour.us](http://www.srsuntour.us)



**HIGH PERFORMANCE SYNTHETIC GREASE**  
low friction grease for suspension forks and rear shocks lubrication, 350g



**EXTRA LONG ALLEN WRENCH**  
350x5mm (ZFC021) / 350x6mm (ZFC171). Special tool for swing shock forks and bent design forks.

# WEBSITE & SOCIAL MEDIA GUIDE

## CORPORATE WEBSITE

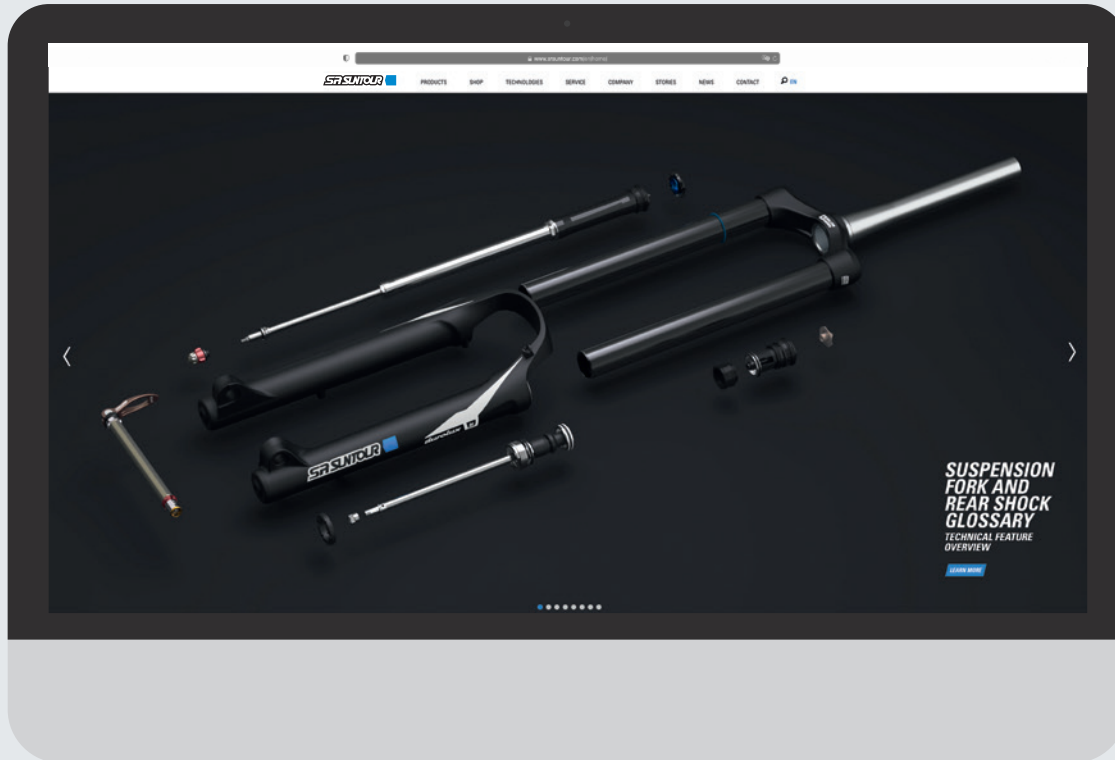

### WWW.SRSUNTOUR.COM

- Product and event news
- Fork Identification Tool
- Service (Tech Videos, Service Request, Product Registration, Service Network, Fork Glossary)
- New Videos
- Worldwide contact information (Headquarters, Subsidiaries, Distributors)
- Download area: 3D exploded views, Owners manuals, Workshop books, Videos, E-Bike-Service
- Dealer Download Area - on demand

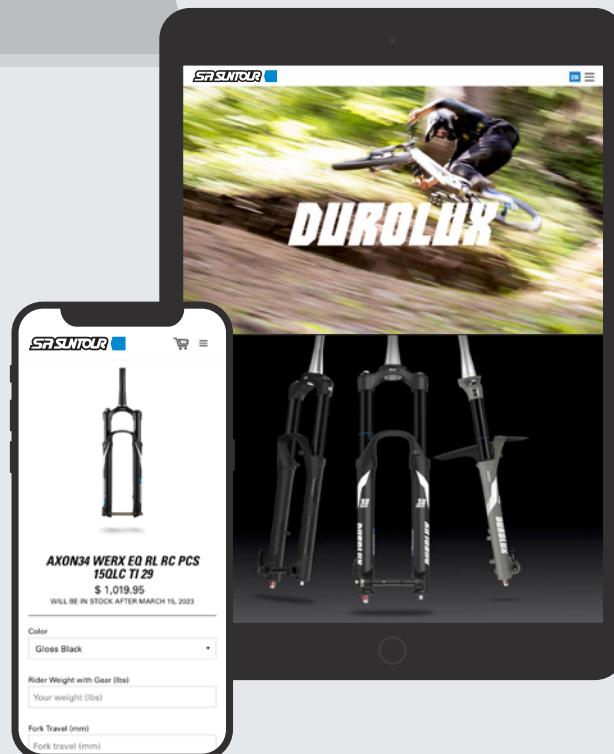

# SOCIAL MEDIA

FACEBOOK  
ACCOUNT

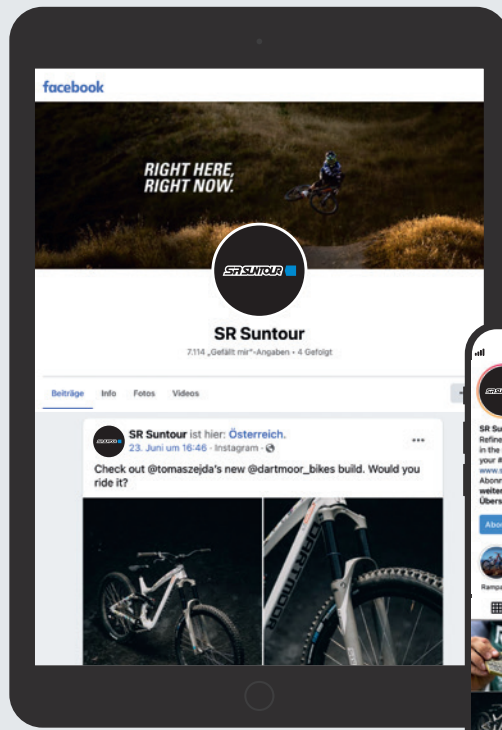

FACEBOOK: [www.facebook.com/srsuntourinc](http://www.facebook.com/srsuntourinc)

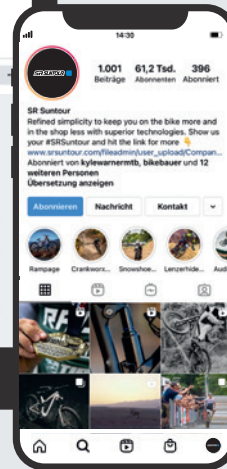

INSTAGRAM  
ACCOUNT



INSTAGRAM: [www.instagram.com/srsuntour\\_inc](http://www.instagram.com/srsuntour_inc)

# VIDEO

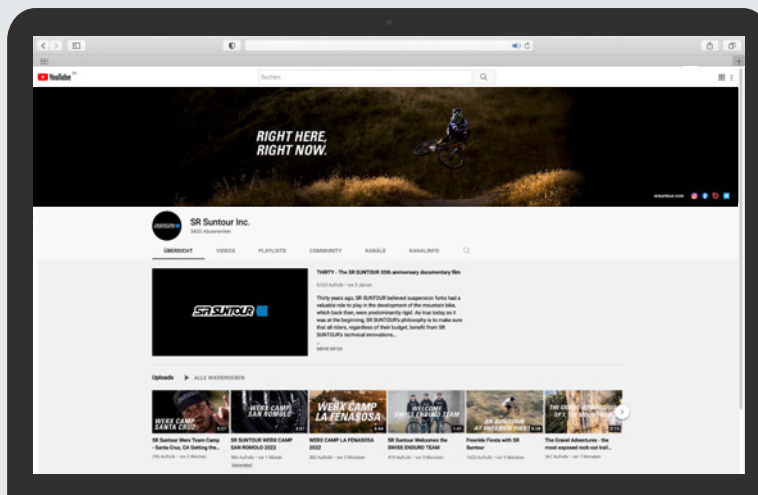

YOUTUBE CHANNEL: [goo.gl/2tupiU](http://goo.gl/2tupiU)

- Tech manual videos
- Action videos
- Product promotion videos

# WORLDWIDE DISTRIBUTORS & SUBSIDIARIES

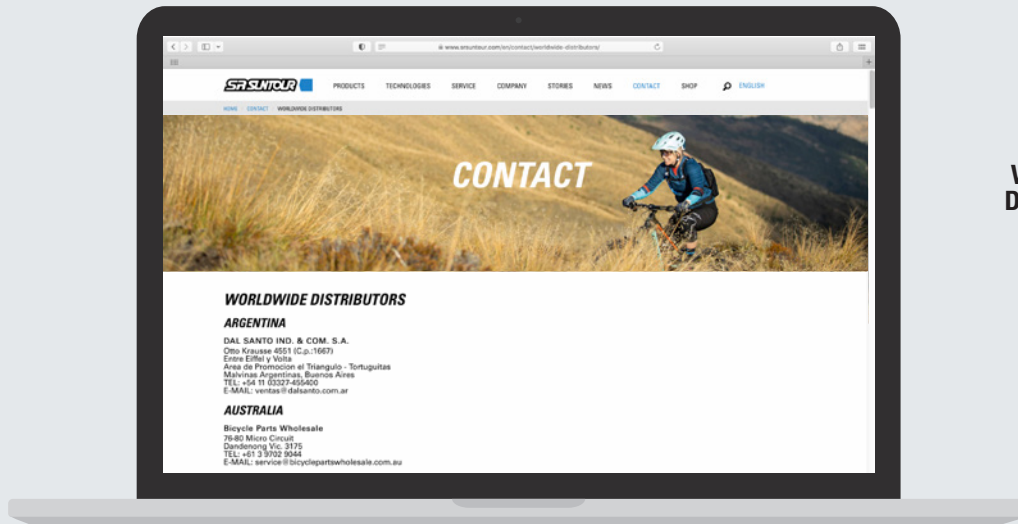

## WORLDWIDE-DISTRIBUTORS



WEBSITE: [www.srsuntour.com/contact/worldwide-distributors/](http://www.srsuntour.com/contact/worldwide-distributors/)



Concept, Graphic design, layout and photos by WHYEX [www.whyex.com](http://www.whyex.com)  
Art Direction: Tobias Guidone  
Photography: Hoshi Yoshida, Jordi Mollfuleda, Juan Duarte, Rémi Cordier  
Copyright © 2024 SR SUNTOUR inc. All rights reserved. Specifications are subject to change for improvement without notice.

This catalogue depicts images of riding and stunts performed by professional riders under very strict control and supervision. Avoid personal injury, death or damage to your bicycle. Never attempt to recreate or perform any activity depicted in this catalogue.

## SR SUNTOUR CORPORATE

---

### **TAIWAN HEADQUARTER**

**SR SUNTOUR INC.**  
#7 Hsing Yeh Rd.,  
Fu Hsing Industrial Zone, Chang Hua  
Taiwan 506027  
Tel. +886-4-7695115  
Fax. +886-4-7694028  
service@srsuntour.com.tw

### **GERMANY (EU)**

**SR SUNTOUR DÜSSELDORF GMBH**  
Fichtenstr. 115  
40233 Düsseldorf  
Germany  
Tel. +49-2115-42689-50  
Fax. +49-2115-42347-76

### **CHINA (SHEN ZHEN)**

**SR SUNTOUR SHEN ZHEN CO. LTD**  
Suibei Industrial Zone, Suibei Rd.,  
Gongming Town,  
Guangming District,  
Shen Zhen, China  
Tel. +86-755-27105433  
Fax. +86-755-27105633

### **USA**

**SR SUNTOUR NORTH AMERICA**  
14511 NE 10th Avenue  
Vancouver WA 98685  
United States  
Tel. 360-737-6450  
service@srsuntourna.com

### **CHINA (KUN SHAN)**

**SR SUNTOUR KUN SHAN CO. LTD**  
1500 Honghu Rd., Peng Lang,  
Kun Shan Development Zone,  
Jiang Su Province, China  
Tel. +86-512-5518-8088  
Fax. +86-512-5517-1117

### **USA**

**SR SUNTOUR SERVICE CENTER**  
910 Watson Avenue  
Madison WI 53713  
United States  
Tel. 608-229-6610  
service@usulcorp.com

### **VIETNAM**

**SR SUNTOUR VIETNAM CO. LTD**  
Lot. 17-8, Street 3B,  
Protrade International Tech Park,  
An Tay Commune, Ben Cat Town,  
Binh Duong Province, Vietnam.  
Tel. +84-(0)274-3721-883  
Tax Code: 3702401047

### **FRANCE (EU)**

**SR SUNTOUR FRANCE SAS**  
Alpespace  
604 Voie Galilée,  
73800 Sainte-Hélène-Du-Lac, France  
Tel. +33-4-85-86-00-99  
Fax. +33-4-79-28-69-71  
sav@srsuntour-cycling.com

### **JAPAN**

**SR SUNTOUR JAPAN**  
NR Bldg. 4F, 3-13-13  
Kuramae, Taito-ku,  
Tokyo 111-0051, Japan  
Tel. +81-(0)3-5829-9211  
Fax. +81-(0)3-5829-9241

### **BELGIUM (EU)**

**SR SUNTOUR EUROPE S.A.**  
Bld. Henri Rolin 5Bis  
1410 Waterloo Belgium  
Tel. +32-23544676  
Fax. +32-23547835  
Sales.sab@srsuntourcycling.com

### **GERMANY (EU)**

**SR SUNTOUR EUROPE GMBH**  
Riedstrasse 31  
83627 Warngau  
Germany  
Tel. +49-8021-50793-0  
Fax. +49-8021-50793-29  
service@srsuntour-cycling.com

### **WWW.SRSUNTOUR.COM**

Copyright © 2024 SR SUNTOUR inc. All rights reserved. Specifications are subject to change for improvement without notice.

**REFINED  
SIMPLICITY™**

**SR SUNTOUR** 